

JVC

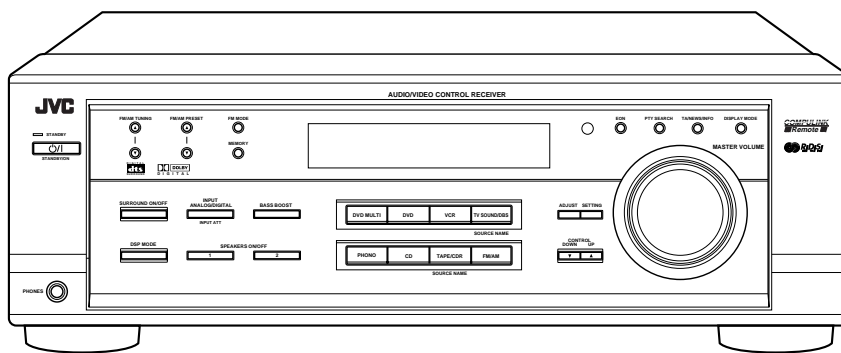

AUDIO/VIDEO CONTROL RECEIVER

RX-7010RBK / RX-7012RSL

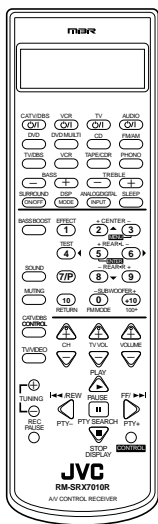

COMPU LINK
Remote

DIGITAL
dts
SURROUND

DOLBY
DIGITAL

DTS
ES



INSTRUCTIONS

For Customer Use:

Enter below the Model No. and Serial No. which are located either on the rear, bottom or side of the cabinet. Retain this information for future reference.

Model No. _____

Serial No. _____

LVT0579-005A

[B]

Warnings, Cautions and Others

IMPORTANT for the U.K.

DO NOT cut off the mains plug from this equipment. If the plug fitted is not suitable for the power points in your home or the cable is too short to reach a power point, then obtain an appropriate safety approved extension lead or consult your dealer.

BE SURE to replace the fuse only with an identical approved type, as originally fitted.

If nonetheless the mains plug is cut off ensure to remove the fuse and dispose of the plug immediately, to avoid a possible shock hazard by inadvertent connection to the mains supply.

If this product is not supplied fitted with a mains plug then follow the instructions given below:

IMPORTANT.

DO NOT make any connection to the terminal which is marked with the letter E or by the safety earth symbol or coloured green or green-and-yellow.

The wires in the mains lead on this product are coloured in accordance with the following code:

Blue : Neutral
Brown : Live

As these colours may not correspond with the coloured markings identifying the terminals in your plug proceed as follows:

The wire which is coloured blue must be connected to the terminal which is marked with the letter N or coloured black.

The wire which is coloured brown must be connected to the terminal which is marked with the letter L or coloured red.

IF IN DOUBT - CONSULT A COMPETENT ELECTRICIAN.

CAUTION

To reduce the risk of electrical shocks, fire, etc.:

1. Do not remove screws, covers or cabinet.
2. Do not expose this appliance to rain or moisture.

Caution — ⏻/I switch!

Disconnect the mains plug to shut the power off completely.

The ⏻/I switch in any position does not disconnect the mains line. The power can be remote controlled.

CAUTION

- Do not block the ventilation openings or holes.
(If the ventilation openings or holes are blocked by a newspaper or cloth, etc., the heat may not be able to get out.)
- Do not place any naked flame sources, such as lighted candles, on the apparatus.
- When discarding batteries, environmental problems must be considered and local rules or laws governing the disposal of these batteries must be followed strictly.
- Do not use this apparatus in a bathroom or places with water. Also do not place any containers filled with water or liquids (such as cosmetics or medicines, flower vases, potted plants, cups, etc.) on top of this apparatus.

SAFETY INSTRUCTIONS

“SOME DOS AND DON'TS ON THE SAFE USE OF EQUIPMENT”

This equipment has been designed and manufactured to meet international safety standards but, like any electrical equipment, care must be taken if you are to obtain the best results and safety is to be assured.

Do read the operating instructions before you attempt to use the equipment.

Do ensure that all electrical connections (including the mains plug, extension leads and interconnections between pieces of equipment) are properly made and in accordance with the manufacturer's instructions. Switch off and withdraw the mains plug when making or changing connections.

Do consult your dealer if you are ever in doubt about the installation, operation or safety of your equipment.

Do be careful with glass panels or doors on equipment.

DON'T continue to operate the equipment if you are in any doubt about it working normally, or if it is damaged in any way—switch off, withdraw the mains plug and consult your dealer.

DON'T remove any fixed cover as this may expose dangerous voltages.

DON'T leave equipment switched on when it is unattended unless it is specifically stated that it is designed for unattended operation or has a standby mode.
Switch off using the switch on the equipment and make sure that your family know how to do this.

Special arrangements may need to be made for infirm or handicapped people.

DON'T use equipment such as personal stereos or radios so that you are distracted from the requirements of traffic safety. It is illegal to watch television whilst driving.

DON'T listen to headphones at high volume as such use can permanently damage your hearing.

DON'T obstruct the ventilation of the equipment, for example with curtains or soft furnishings.

Overheating will cause damage and shorten the life of the equipment.

DON'T use makeshift stands and NEVER fix legs with wood screws — to ensure complete safety always fit the manufacturer's approved stand or legs with the fixings provided according to the instructions.

DON'T allow electrical equipment to be exposed to rain or moisture.

ABOVE ALL

- NEVER let anyone, especially children, push anything into holes, slots or any other opening in the case -this could result in a fatal electrical shock.;
- NEVER guess or take chances with electrical equipment of any kind — it is better to be safe than sorry!

Caution: Proper Ventilation

To avoid risk of electric shock and fire and to protect from damage.

Locate the apparatus as follows:

- Front: No obstructions open spacing.
- Sides: No obstructions in 10 cm from the sides.
- Top: No obstructions in 10 cm from the top.
- Back: No obstructions in 15 cm from the back
- Bottom: No obstructions, place on the level surface.

In addition, maintain the best possible air circulation as illustrated.

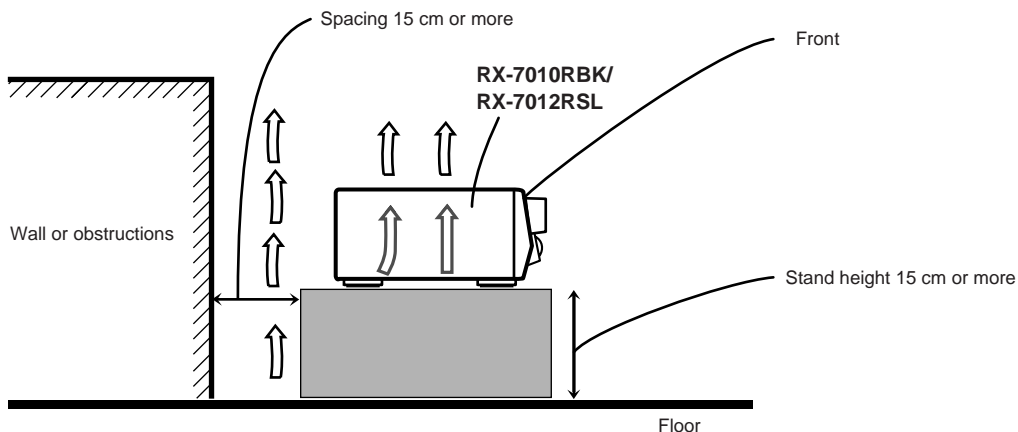
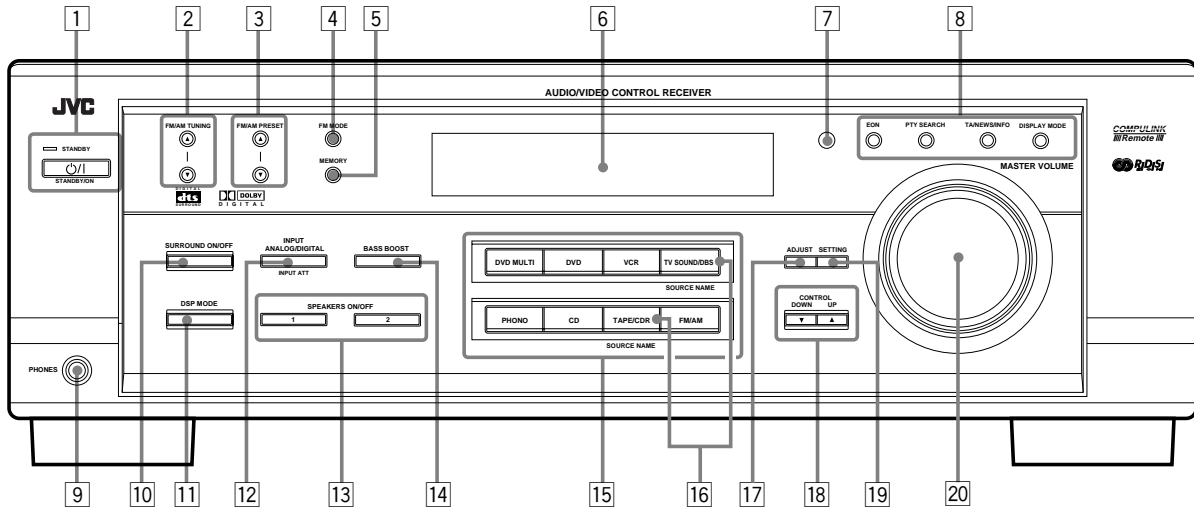

Table of Contents

Parts Identification	2	Using the DVD MULTI Playback Mode	30
Getting Started	3	Activating the DVD MULTI Playback Mode	30
Before Installation	3	COMPU LINK Remote Control System	31
Checking the Supplied Accessories	3	Operating JVC's Audio/Video Components ...	32
Connecting the FM and AM (MW/LW) Antennas	3	Operating Audio Components	32
Connecting the Speakers	4	Operating Video Components	34
Connecting Audio/Video Components	5	Operating Other Manufacturers' Video	
Connecting the Power Cord	9	Equipment	35
Putting Batteries in the Remote Control	9	Troubleshooting	39
Basic Operations	10	Specifications	40
Turning the Power On and Off (Standby)	10		
Selecting the Source to Play	10		
Adjusting the Volume	11		
Selecting the Front Speakers	11		
Muting the Sound	12		
Reinforcing the Bass	12		
Adjusting the Tone	12		
Attenuating the Input Signal	12		
Adjusting the Subwoofer Output Level	12		
Basic Settings	13		
Recording a Source	13		
Adjusting the Front Speaker Output Balance	13		
Changing the Source Name	13		
Setting the Subwoofer Information	14		
Setting the Speakers for the DSP Modes	14		
Digital Input (DIGITAL IN) Terminal Setting	16		
Selecting the Analog or Digital Input Mode	16		
Storing the Basic Settings and Adjustments	17		
Using the Sleep Timer	17		
Receiving Radio Broadcasts	18		
Tuning in Stations Manually	18		
Using Preset Tuning	18		
Selecting the FM Reception Mode	19		
Using the RDS (Radio Data System) to Receive FM Stations ..	20		
Searching for a Program by PTY Codes	20		
Switching to a Broadcast Program of Your Choice Temporarily	21		
Using the DSP Modes	23		
What are the DSP Modes?	23		
Reproducing the Sound Field	24		
Available DSP Modes According to the Speaker Arrangement ..	25		
Adjusting the Surround Modes	26		
Adjusting the DAP Modes	28		
Activating the DSP Modes	29		

Parts Identification

Become familiar with the buttons and controls on the receiver before use.
Refer to the pages in parentheses for details.



Remote Control

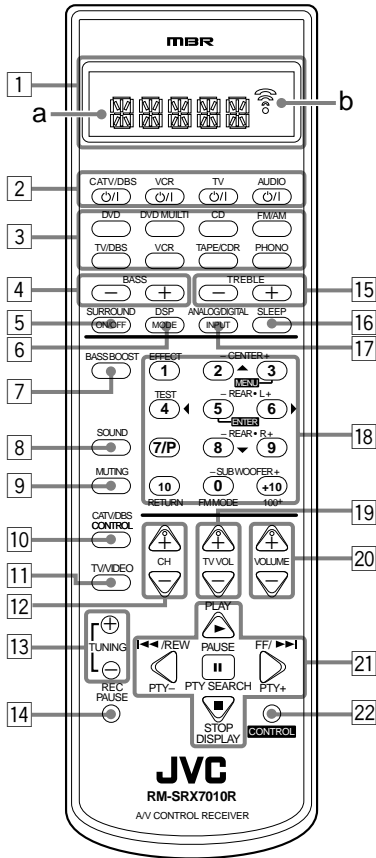

- 1 Display window (See below) *
a: Remote control operation mode indicator
b: Signal transmission indicator
- 2 O/I buttons (10, 34 – 38)
CATV/DBS, VCR, TV, AUDIO
- 3 Source selecting buttons (10, 17) *
DVD, DVD MULTI, CD, FM/AM, TV/DBS, VCR, TAPE/CDR, PHONO
- 4 BASS +/- buttons (12)
- 5 SURROUND ON/OFF button (26, 29)
- 6 DSP MODE button (27 – 29)
- 7 BASS BOOST button (12)
- 8 SOUND button (12, 26 – 28, 30) *
- 9 MUTING button (12)
- 10 CATV/DBS CONTROL button (36) *
- 11 TV/VIDEO button (34, 35)
- 12 CH(annel) +/- buttons (34 – 37)
- 13 TUNING +/- buttons (18)
- 14 REC PAUSE button (33, 34, 37)
- 15 TREBLE +/- buttons (12)
- 16 SLEEP button (17)
- 17 ANALOG/DIGITAL INPUT button (17)
- 18 • 10 keys for selecting preset channels (19)
• 10 keys for adjusting sound (12, 19, 26 – 28, 30)
• 10 keys for operating audio/video components (32 – 38)
- 19 TV VOL(ume) +/- buttons (34, 35)
- 20 VOLUME +/- buttons (11)
- 21 • RDS operation buttons (20 – 21)
PTY SEARCH, PTY +/-, DISPLAY
• Operating buttons for audio/video components (32 – 34, 37, 38)
- 22 CONTROL button (33, 34) *

Front Panel

- 1 STANDBY/ON O/I button and STANDBY lamp (10)
- 2 FM/AM TUNING $\blacktriangle/\blacktriangledown$ buttons (18)
- 3 FM/AM PRESET $\blacktriangle/\blacktriangledown$ buttons (18)
- 4 FM MODE button (19)
- 5 MEMORY button (18)
- 6 Display (10)
- 7 Remote sensor (9)
- 8 RDS operation buttons (20 – 21)
EON, PTY SEARCH, TA/NEWS/INFO, DISPLAY MODE
- 9 PHONES jack (11)
- 10 SURROUND ON/OFF button (26, 29)
- 11 DSP MODE button (27 – 29)
- 12 INPUT ANALOG/DIGITAL button (17)
INPUT ATT button (12)
- 13 SPEAKERS ON/OFF 1 button (11)
SPEAKERS ON/OFF 2 button (11)
- 14 BASS BOOST button (12)
- 15 Source selecting buttons (10, 16)
DVD MULTI, DVD, VCR, TV SOUND/DBS, PHONO, CD, TAPE/CDR, FM/AM
- 16 SOURCE NAME buttons (13)
• The TV SOUND/DBS button and TAPE/CDR button also function as the SOURCE NAME button.
- 17 ADJUST button (12, 13, 26 – 28, 30)
- 18 CONTROL UP \blacktriangle /DOWN \blacktriangledown buttons
- 19 SETTING button (14 – 16)
- 20 MASTER VOLUME control (11)

* When you press one of these buttons, the remote control operation mode appears on the display window for about 10 seconds.

Ex.: When you press CD button



Buttons on the Remote Control	Remote Control Operation Mode
FM/AM	TUNER
CD	CD
PHONO	PHONO
TAPE/CDR	TAPE
DVD	DVD
DVD MULTI	DVD

Buttons on the Remote Control	Remote Control Operation Mode
TV/DBS	TV
VCR	VCR
CATV/DBS CONTROL	DBS
CONTROL	Current setting or VCR or TAPE or CDDSC
SOUND	SOUND

Getting Started

This section explains how to connect audio/video components and speakers to the receiver, and how to connect the power supply.

Before Installation

General

- Be sure your hands are dry.
- Turn the power off to all components.
- Read the manuals supplied with the components you are going to connect.

Locations

- Install the receiver in a location that is level and protected from moisture.
- The temperature around the receiver must be between -5°C and 35°C (23°F and 95°F).
- Make sure there is good ventilation around the receiver. Poor ventilation could cause overheating and damage the receiver.

Handling the receiver

- Do not insert any metal object into the receiver.
- Do not disassemble the receiver or remove screws, covers, or cabinet.
- Do not expose the receiver to rain or moisture.

Checking the Supplied Accessories

Check to be sure you have all of the following items, which are supplied with the receiver.

The number in the parentheses indicates quantity of the pieces supplied.

- Remote Control (1)
- Batteries (2)
- AM (MW/LW) Loop Antenna (1)
- FM Antenna (1)

If anything is missing, contact your dealer immediately.

Connecting the FM and AM (MW/LW) Antennas

FM Antenna Connections

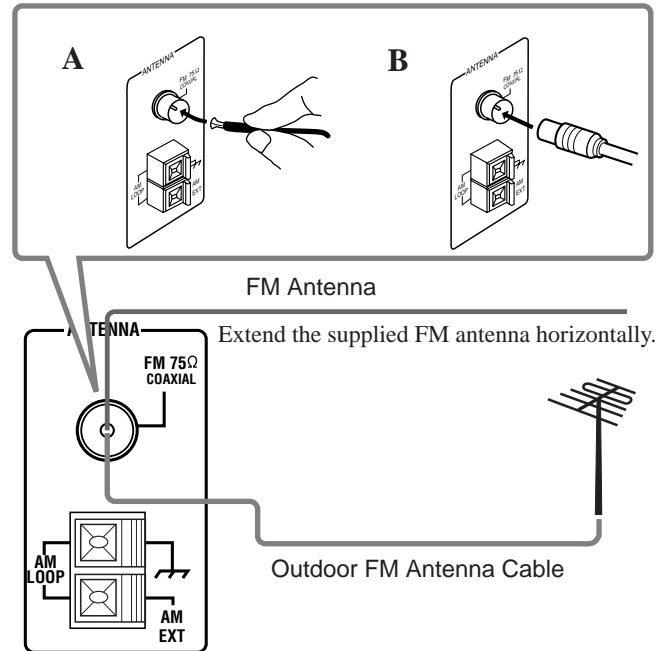

A. Using the Supplied FM Antenna

The FM antenna provided can be connected to the FM 75 Ω COAXIAL terminal as temporary measure.

B. Using the Standard Type Connector (Not Supplied)

A standard type connector (IEC or DIN45325) should be connected to the FM 75 Ω COAXIAL terminal.

Note:

If reception is poor, connect the outdoor antenna. Before attaching a 75 Ω coaxial cable (the kind with a round wire going to an outdoor antenna), disconnect the supplied FM antenna.

AM (MW/LW) Antenna Connections

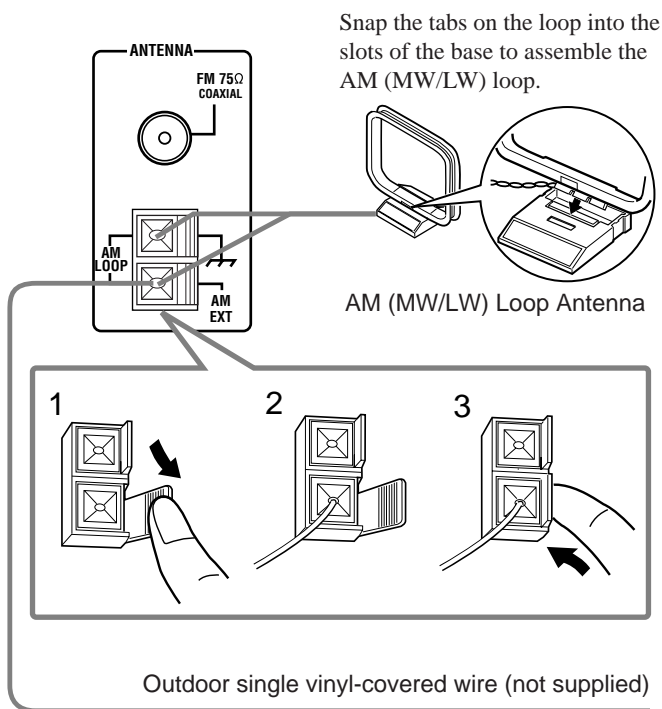

Turn the loop until you have the best reception.

Notes:

- If the AM (MW/LW) loop antenna wire is covered with vinyl, remove the vinyl by twisting it as shown in the diagram.
- Make sure the antenna conductors do not touch any other terminals, connecting cords and power cord. This could cause poor reception.
- If reception is poor, connect an outdoor single vinyl-covered wire to the AM EXT terminal. (Keep the AM (MW/LW) loop antenna connected.)



Connecting the Speakers

You can connect the following speakers:

- Two pairs of front speakers to produce normal stereo sound.
- One pair of rear speakers to enjoy the surround effect.
- One center speaker to produce more effective surround effect (to emphasize human voices).
- One subwoofer to enhance the bass.

IMPORTANT:

After connecting the speakers listed above, set the speaker setting information properly to obtain the best possible DSP effect. For details, see page 14.

For each speaker (except for a subwoofer), connect the (+) and (-) terminals on the rear panel to the (+) and (-) terminals marked on the speakers. For connecting a subwoofer, see page 5.

CAUTION:

Use speakers with the SPEAKER IMPEDANCE indicated by the speaker terminals.

Basic connecting procedure

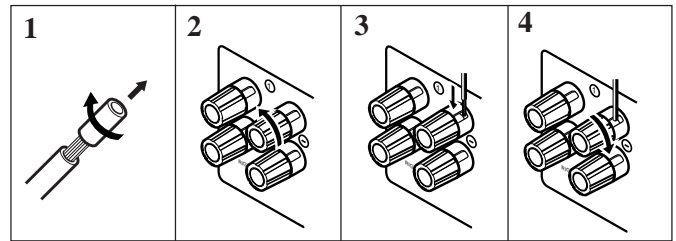

- 1 Cut, twist and remove the insulation at the end of each speaker signal cable (not supplied).
- 2 Turn the knob counterclockwise.
- 3 Insert the speaker signal cable.
- 4 Turn the knob clockwise.

Connecting the front speakers

You can connect two pairs of front speakers (one pair to the FRONT SPEAKERS ① terminals, and another pair to the FRONT SPEAKERS ② terminals).

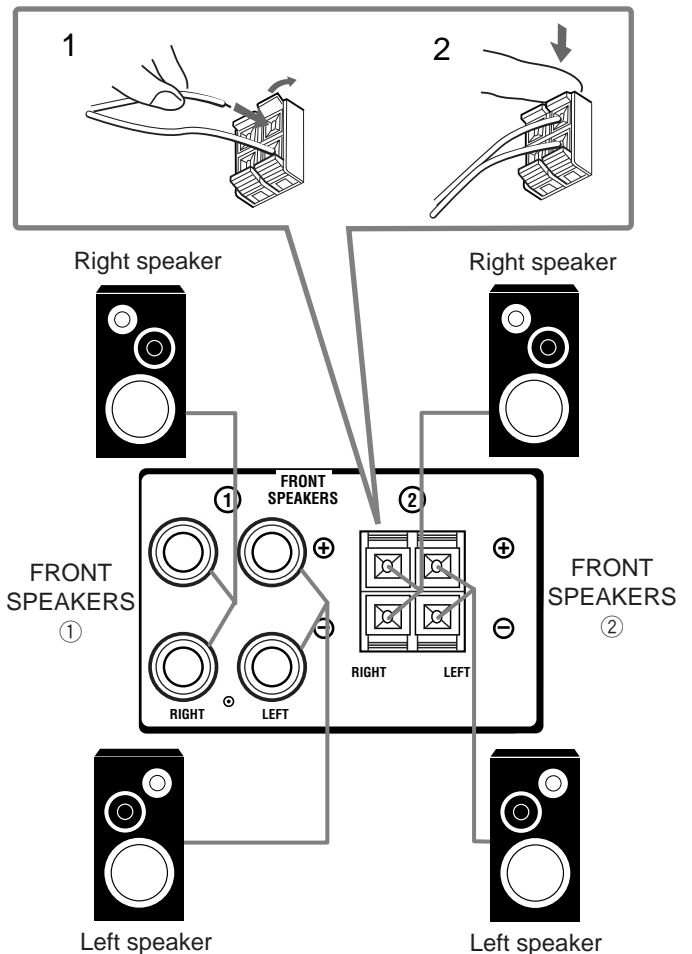

About the speaker impedance

The required speaker impedance of the front speakers does differ depending on whether both the FRONT SPEAKERS ① and FRONT SPEAKERS ② terminals are used or only one of them is used.

CASE 1 When you connect only one pair of front speakers

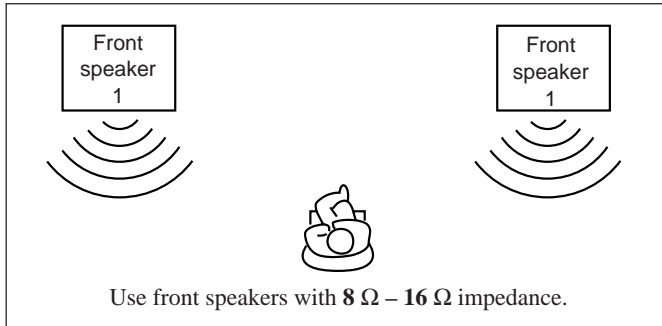

CASE 2 When you connect two pairs of front speakers

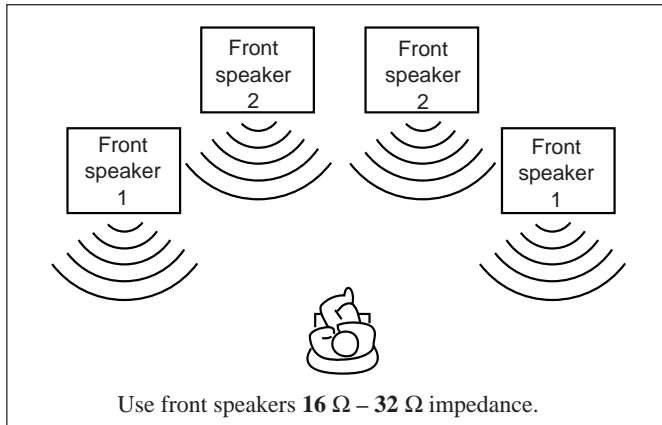

Connecting the rear and center speakers

Connect rear speakers to the REAR SPEAKERS terminals and a center speaker to the CENTER SPEAKER terminals.

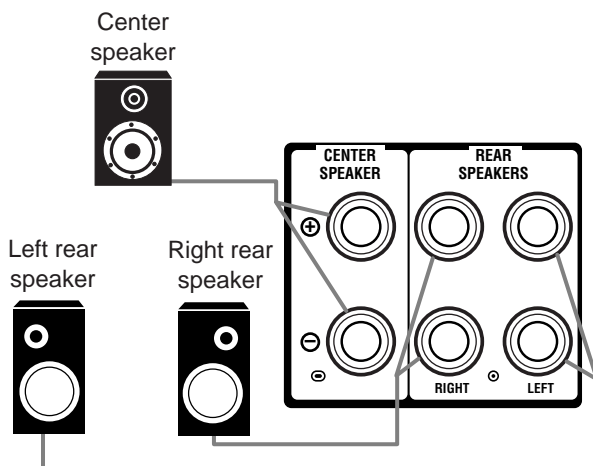

Connecting the subwoofer speaker

You can enhance the bass by connecting a subwoofer. Connect the input jack of a powered subwoofer to the SUBWOOFER OUT jack on the rear panel, using a cable with RCA pin plugs (not supplied).



Connecting Audio/Video Components

You can connect the following audio/video components to this receiver. Refer also to the manuals supplied with your components.

Audio Components	Video Components
• Turntable	• DVD player*
• CD player*	• TV*
• Cassette deck or CD recorder*	• DBS tuner*
	• VCR

* You can connect these components using the methods described in "Analog connections" (below) or in "Digital connections" (see page 8).

Analog connections

Audio component connections

Use the cables with RCA pin plugs (not supplied). Connect the white plug to the audio left jack, and the red plug to the audio right jack.

CAUTION:

If you connect a sound-enhancing device such as a graphic equalizer between the source components and this receiver, the sound output through this receiver may be distorted.

Turntable

If an earth cable is provided for your turntable, connect the cable to the AM (⚡) terminal on the rear panel.

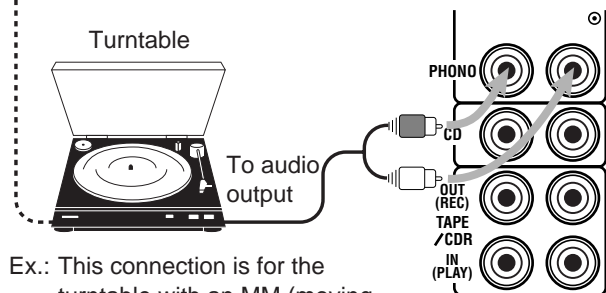

Ex.: This connection is for the turntable with an MM (moving-magnet) type cartridge.

Note:

Any turntables incorporating a small-output cartridge such as an MC (moving-coil) type must be connected to this receiver through a commercial head amplifier or step-up transformer. Direct connection may result in insufficient volume.

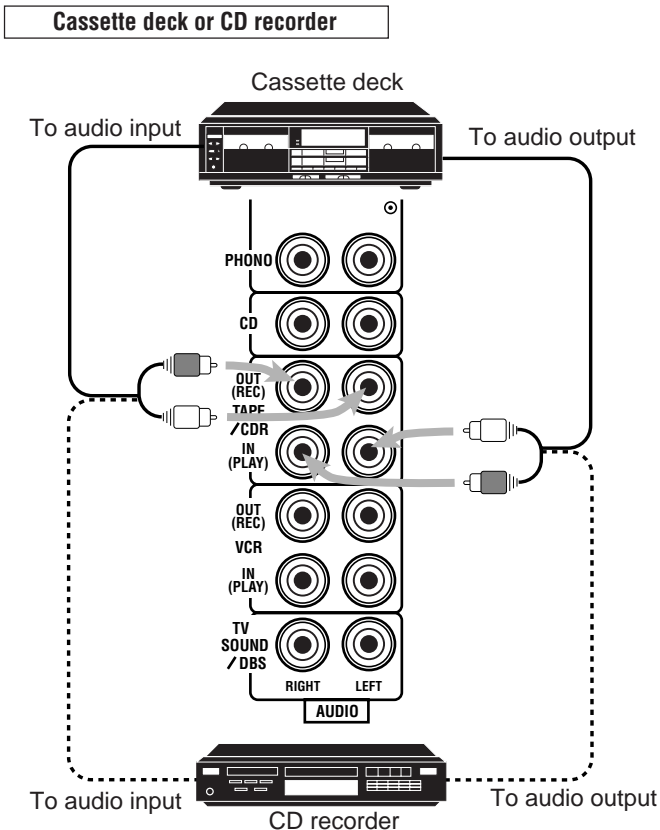
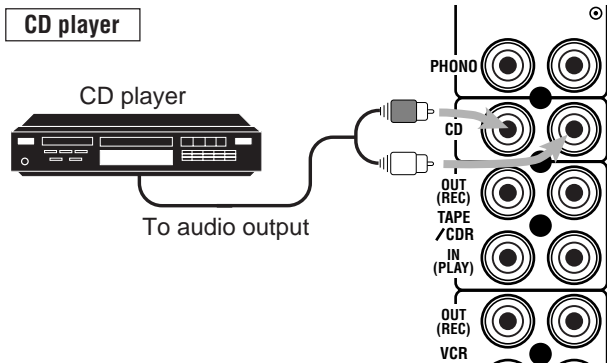

Note:

You can connect either a cassette deck or a CD recorder to the TAPE/CDR jacks. When connecting a CD recorder to the TAPE/CDR jacks, change the source name, which will be shown on the display when selected as the source, to "CDR." See page 13 for details.

If your audio components have a COMPU LINK jack

See also page 31 for detailed information about the connection and the COMPU LINK remote control system.

Video component connections

Use the cables with RCA pin plugs (not supplied).

Connect the white plug to the audio left jack, the red plug to the audio right jack, and the yellow plug to the video jack.

If your video components have S-video (Y/C-separation) terminals, connect them using S-video cables (not supplied). Connecting these video components through the S-video input/output terminals will give you better picture playback (or recording) quality.

IMPORTANT:

This receiver is equipped with both the composite video and S-video input/output terminals for connecting video components.

You do not have to connect both the composite video and S-video terminals.

However, remember that the video signals from the composite video input terminals are output only through the composite video output terminals, while the ones from the S-video input terminals are output only through the S-video output terminals.

Therefore, if a recording video component and a playing video component are connected to the receiver through the different video terminals, you cannot record the picture from the playing component on the recording component. In addition, if the TV and a playing video component are connected to the receiver through the different video terminals, you cannot view the playback picture from the playing component on the TV.

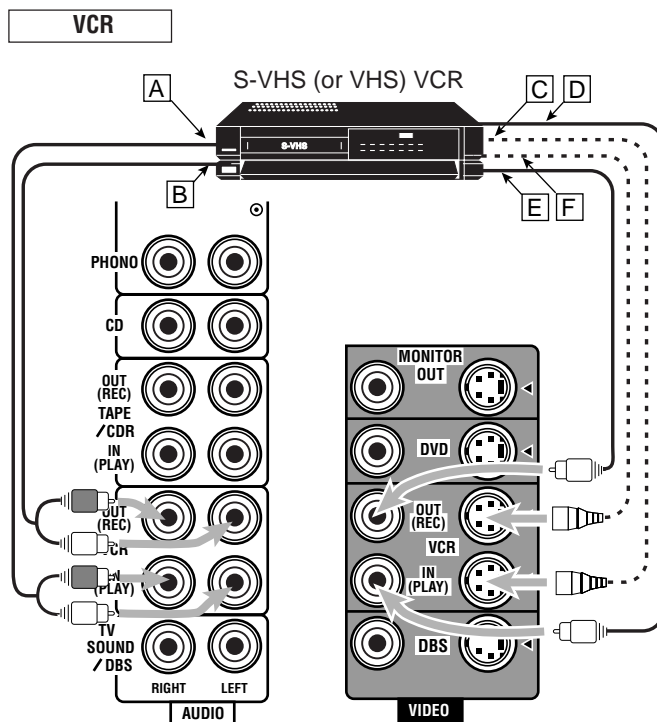

- A To left/right channel audio output
- B To left/right channel audio input
- C To S-video output
- D To composite video output
- E To composite video input
- F To S-video input

TV and/or DBS tuner

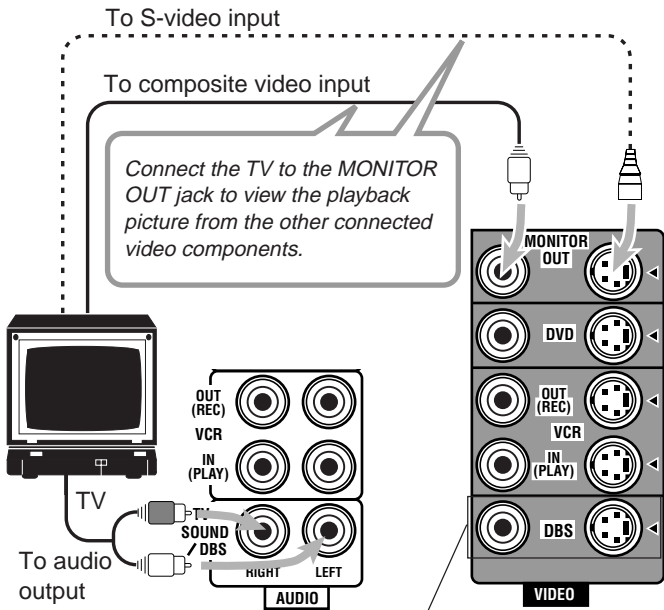

When connecting the TV to the AUDIO jacks (TV SOUND/DBS), DO NOT connect the TV's video output to these video input terminals.

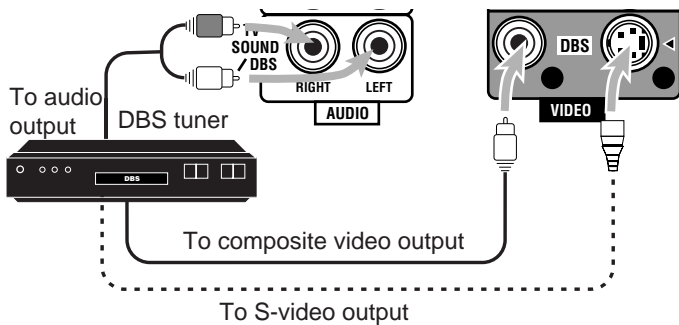

Note:

When connecting the DBS tuner to the TV SOUND/DBS jacks, change the source name, which will be shown on the display when selected as the source, to "DBS." See page 13 for details.

DVD player

- When you connect the DVD player with stereo output jacks:

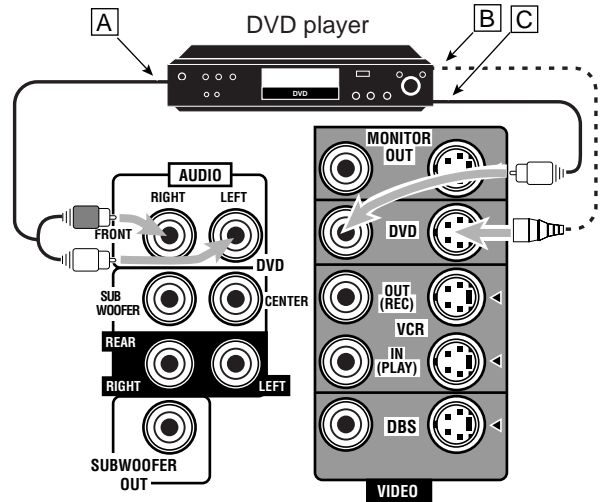

- A To front left/right channel audio output (or to audio mixed output if necessary)
- B To S-video output
- C To composite video output

- When you connect the DVD player with its analog discrete output (5.1 CH reproduction) jacks:

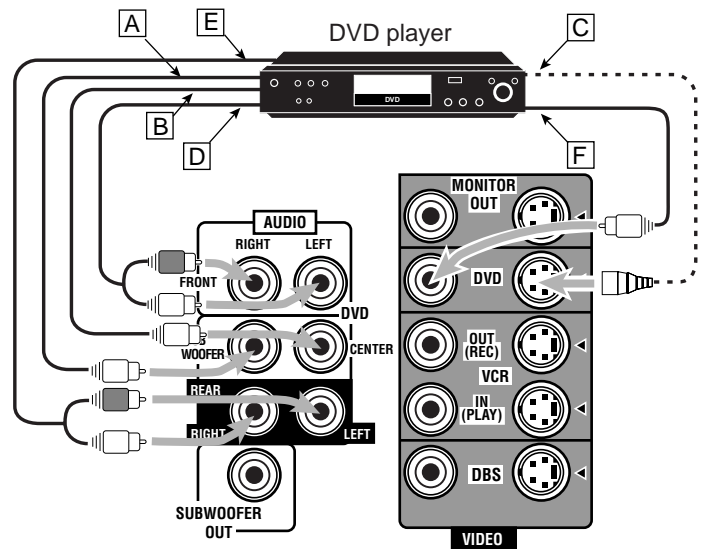

- A To center channel audio output
- B To subwoofer audio output
- C To S-video output
- D To front left/right channel audio output
- E To rear left/right channel audio output
- F To composite video output

Digital connections

This receiver is equipped with four DIGITAL IN terminals — one digital coaxial terminal and three digital optical terminals, and one DIGITAL OUT terminal.

You can connect any digital equipment such as —

- DBS tuner,
- Digital TV broadcast tuner,
- DVD player,
- CD player, and
- CD recorder.

IMPORTANT:

- When connecting the DVD player, digital TV broadcast tuner or DBS tuner using the digital terminals, you also need to connect it to the video jack (either composite video terminal or S-video terminal) on the rear. Without connecting it to the video jack, you can view no playback picture.
- After connecting the components using the DIGITAL IN terminals, set the following correctly if necessary.
 - Set the digital input (DIGITAL IN) terminal setting correctly. For details, see “Digital Input (DIGITAL IN) Terminal Setting” on page 16.
 - Select the digital input mode correctly. For details, see “Selecting the Analog or Digital Input Mode” on page 16.

Digital input terminals

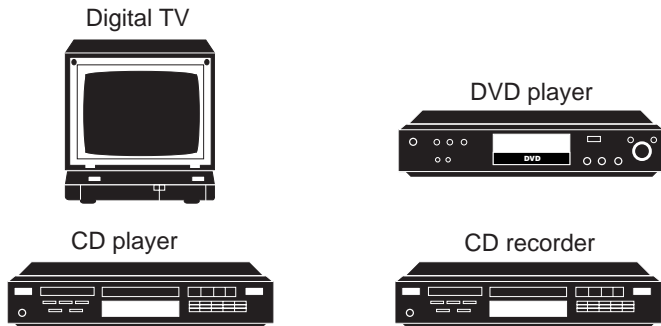

Digital coaxial cable (not supplied)
between digital coaxial terminals

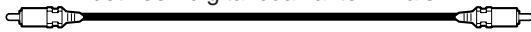

Digital optical cable (not supplied)
between digital optical terminals



When the component has a digital coaxial output terminal, connect it to the DIGITAL 1 (DVD) terminal, using the digital coaxial cable (not supplied).

When the component has a digital optical output terminal, connect it to the DIGITAL 2 (CD), DIGITAL 3 (TV), or DIGITAL 4 (CDR) terminal, using the digital optical cable (not supplied).

Before connecting a digital optical cable, unplug the protective plug.

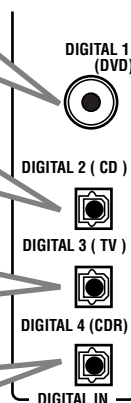
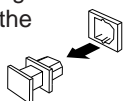

Notes:

- When shipped from the factory, the DIGITAL IN terminals have been set for use with the following components.
 - DIGITAL 1 (coaxial): For DVD player
 - DIGITAL 2 (optical): For CD player
 - DIGITAL 3 (optical): For digital TV broadcast tuner
 - DIGITAL 4 (optical): For CD recorder
- When you want to operate the CD player or CD recorder using the COMPU LINK remote control system, connect the target component also as described in “Analog connections” (see page 6).

Digital output terminal

CD recorder, etc.



Digital optical cable (not supplied)
between digital optical terminals



When the digital recording equipment such as a CD recorder has a digital optical input terminal, connecting it to the DIGITAL OUT terminal enables you to perform digital-to-digital recording.

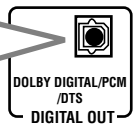

Connecting the Power Cord

Before plugging the receiver into an AC outlet, make sure that all connections have been made.

Plug the power cord into an AC outlet.

Keep the power cord away from the connecting cables and the antenna. The power cord may cause noise or screen interference. We recommend that you use a coaxial cable to connect the antenna, since it is well-shielded against interference.

Note:

The preset settings such as preset channels and sound adjustment may be erased in a few days in the following cases:

- When you unplug the power cord.
- When a power failure occurs.

CAUTIONS:

- Do not touch the power cord with wet hands.
- Do not pull on the power cord to unplug the cord. When unplugging the cord, always grasp the plug so as not to damage the cord.

Putting Batteries in the Remote Control

Before using the remote control, put two supplied batteries first. When using the remote control, aim the remote control directly at the remote sensor on the receiver.

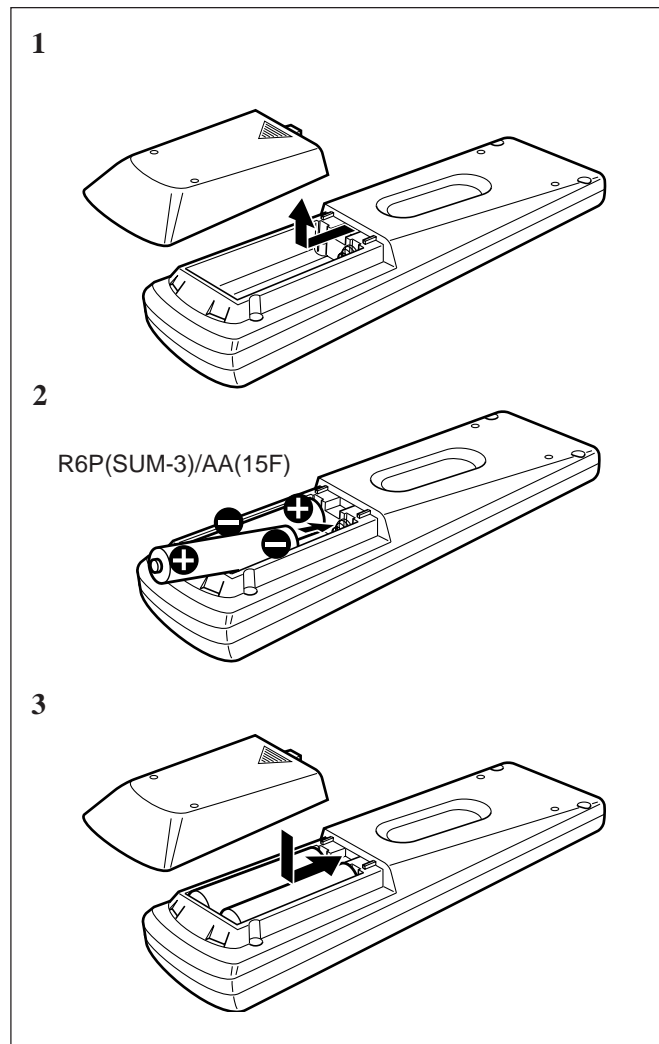

- 1. On the back of the remote control, remove the battery cover.**
- 2. Insert batteries. Make sure to match the polarity: (+) to (+) and (-) to (-).**
- 3. Replace the cover.**

If the range or effectiveness of the remote control decreases, replace the batteries. Use two R6P(SUM-3)/AA(15F) type dry-cell batteries.

CAUTION:

Follow these precautions to avoid leaking or cracking cells:

- Place batteries in the remote control so they match the polarity: (+) to (+) and (-) to (-).
- Use the correct type of batteries. Batteries that look similar may differ in voltage.
- Always replace both batteries at the same time.
- Do not expose batteries to heat or flame.

Basic Operations

The following operations are commonly used when you play any sound source.

Turning the Power On and Off (Standby)

On the front panel:

To turn on the power, press STANDBY/ON . The STANDBY lamp goes off. The name of the current source (or station frequency) appears on the display.

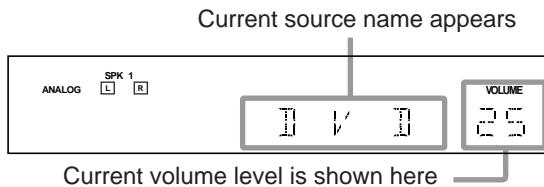
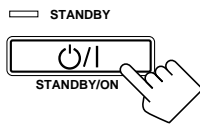

To turn off the power (into standby mode), press STANDBY/ON  again.

The STANDBY lamp lights up. A small amount of power is consumed in standby mode. To turn the power off completely, unplug the AC power cord.

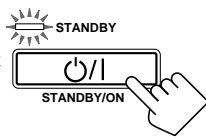

From the remote control:

To turn on the power, press AUDIO . The STANDBY lamp goes off. The name of the current source (or station frequency) appears on the display.



To turn off the power (into standby mode), press AUDIO  again. The STANDBY lamp lights up.

Selecting the Source to Play

Press one of the source selecting buttons.

On the front panel:

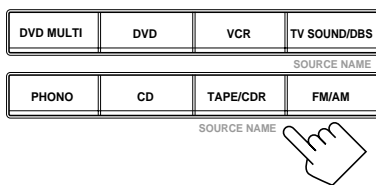

From the remote control:

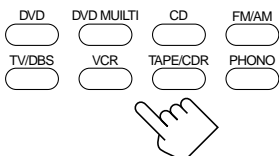

Selected source name appears

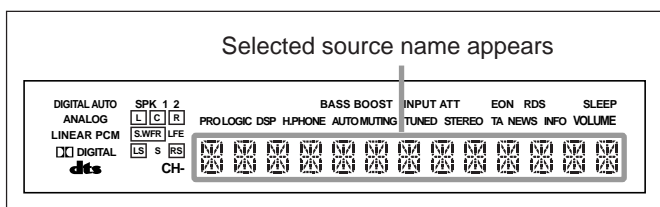

- DVD MULTI Select the DVD player for viewing the digital video disc using the analog discrete output mode (5.1 CH reproduction). To enjoy the DVD MULTI playback, see page 30.
- DVD Select the DVD player.
- VCR Select the video component connected to the VCR jacks.
- TV SOUND/DBS Select TV sounds (or the DBS tuner).
- PHONO* Select the turntable.
- CD* Select the CD player.
- TAPE/CDR* Select the cassette deck (or the CD recorder).
- FM/AM* Select an FM or AM (MW/LW) broadcast.
 - Each time you press the button, the band alternates between FM and AM (MW/LW).

Notes:

- When connecting a CD recorder (to the TAPE/CDR jacks), and a DBS tuner (to the TV SOUND/DBS jacks), change the source name shown on the display. For details, see page 13.
- When you press one of the source selecting buttons on the remote control marked above with an asterisk (*), the receiver automatically turns on.

Signal and speaker indicators on the display

The signal indicators light up in the following cases:

- Only the indicators for the incoming signals light up.
- When analog input is selected, "L" and "R" always light up.
- When "DVD MULTI" is selected as the source, "L," "C," "R," "LFE," "LS" and "RS" light up.

The speaker indicators light up only —:

- When the corresponding speaker is activated.

AND

- When the corresponding speaker is required for the DSP mode selected currently.

Signal indicators light up in red:	Speaker indicators light up in white:

- L:
 - When digital input is selected: Lights up when the left channel signal comes in.
 - When analog input is selected: Always lights up.
- R:
 - When digital input is selected: Lights up when the right channel signal comes in.
 - When analog input is selected: Always lights up.
- C: Lights up when the center channel signal comes in.
- LS: Lights up when the left rear channel signal comes in.
- RS: Lights up when the right rear channel signal comes in.
- S: Lights up when the monaural rear channel signal comes in.
- LFE: Lights up when the LFE channel signal comes in.

Notes:

- When "SUBWOOFER" is set to "YES,"  lights up.
- When you select "DVD MULTI," all the signal indicators except "S" light up.

Selecting different sources for picture and sound

You can watch picture from a video component while listening to sound from another component.

Press one of the audio source selecting buttons — PHONO, CD, TAPE/CDR, FM/AM, TV SOUND/DBS* (or TV/DBS on the remote control), while viewing the picture from a video component such as the VCR, DVD player, or DBS tuner, etc.

Notes:

- Once you have selected a video source, pictures of the selected source are sent to the TV until you select another video source.
- * The TV SOUND/DBS (or TV/DBS on the remote control) only works for selecting "DBS" as the source but not for selecting "TV SOUND (or TV on the remote control)." When you use the DBS tuner, change the source name correctly (see page 13).

Adjusting the Volume

On the front panel:

To increase the volume, turn MASTER VOLUME clockwise.

To decrease the volume, turn it counterclockwise.

- When you turn MASTER VOLUME rapidly, the volume level also changes rapidly.
- When you turn MASTER VOLUME slowly, the volume level also changes slowly.

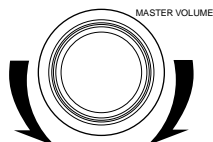

From the remote control:

To increase the volume, press VOLUME +.

To decrease the volume, press VOLUME -.

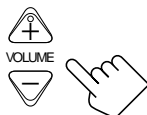

CAUTION:

Always set the volume to the minimum before starting any source. If the volume is set at its high level, the sudden blast of sound energy can permanently damage your hearing and/or ruin your speakers.

Note:

The volume level can be adjusted within the range of "0" (minimum) to "80" (maximum).

Selecting the Front Speakers

On the front panel ONLY:

When you have connected two pairs of the front speakers, you can select which to use.

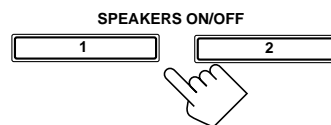

To use the speakers connected to the FRONT SPEAKERS ① terminals, press SPEAKERS ON/OFF 1 so that the SPK 1 indicator lights up on the display. (Make sure that the SPK 2 is not on the display.)

To use the speakers connected to the FRONT SPEAKERS ② terminals, press SPEAKERS ON/OFF 2 so that the SPK 2 indicator lights up on the display. (Make sure that the SPK 1 is not on the display.)

To use both sets of the speakers, press SPEAKERS ON/OFF 1 and 2 so that the SPK 1 and SPK 2 indicators light up on the display.

To use neither sets of the speakers, press SPEAKERS ON/OFF 1 and 2 so that the SPK 1 and SPK 2 indicators disappear from the display.

Notes:

- If you select any of the DSP modes while using both the speakers connected to the FRONT SPEAKERS ① and ② terminals, the speakers connected to the FRONT SPEAKERS ② terminals are deactivated.
- While the DSP MODE is in use, you can only select either the speakers connected to the FRONT SPEAKERS ① or ② terminals.

Listening only with headphones

You must turn off both pairs of speakers when you listen with headphones.

1. Connect a pair of headphones to the PHONES jack on the front panel.
2. Press SPEAKERS ON/OFF 1 and SPEAKERS ON/OFF 2 so that neither the SPK 1 nor SPK 2 indicator appears on the display.

This cancels the DSP mode currently selected, and activates the HEADPHONE mode (see below).

- "HEADPHONE" appears and H. PHONE indicator lights up on the display.

HEADPHONE mode:

This mode can reproduce the LFE channel signals, mixing them with the front channel signals. So you will not miss the subwoofer sounds even if you listen to a source using the headphones.

Notes:

- While in the HEADPHONE mode, you cannot use any DSP modes (see page 23.)
- Activating the speaker cancels the HEADPHONE mode and turns on the DSP mode previously selected.

CAUTION:

Be sure to turn down the volume before connecting or putting on headphones, as high volume can damage both the headphones and your hearing.

Muting the Sound

From the remote control ONLY:

Press **MUTING** to mute the sound through all speakers and headphones connected.

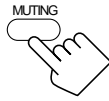

“MUTING” appears on the display and the volume turns off (the volume level indicator goes off).

To restore the sound, press **MUTING** again so that “OFF” appears on the display.

- Turning **MASTER VOLUME** on the front panel or pressing **VOLUME +/-** on the remote control also restores the sound.

Reinforcing the Bass

You can boost the bass level.

Press **BASS BOOST** on the front panel or on the remote control to select the bass boost function.

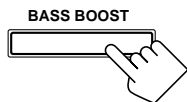

On the front panel



On the remote control

- Each time you press the button, the bass boost function turns on (“BASSBOOST ON”) and off (“BASSBOOST OFF”).
- Select “BASSBOOST ON” to activate the bass boost function. The **BASS BOOST** indicator lights up on the display.
- Select “BASSBOOST OFF” to cancel it. The indicator goes off.

Note:

This function affects the front speaker sounds only.

Adjusting the Tone

You can adjust the bass and treble sounds as you like.

Before you start, remember...

- There is a time limit in doing the following steps. If the setting is canceled before you finish, start from step 1 again.

On the front panel:

1. Press **ADJUST** repeatedly until “**BASS**” or “**TREBLE**” appears on the display.

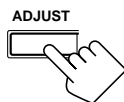

- Select “**BASS**” to adjust the bass sound level.
- Select “**TREBLE**” to adjust the treble sound level.

2. Press **CONTROL UP ▲/DOWN ▼** to adjust the bass or treble sound level (+10 dB to –10 dB).

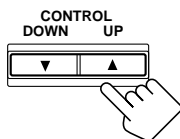

- Each time you press the button, the sound level changes by ± 2 steps.

From the remote control:

Press **BASS +/-** or **TREBLE +/-** to adjust the bass or treble sound level (+10 dB to –10 dB).

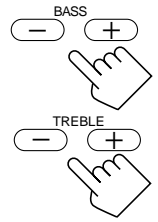

Attenuating the Input Signal

When the input level of the playing source is too high, the sounds will be distorted. If this happens, you need to attenuate the input signal level to prevent the sound distortion.

On the front panel ONLY:

Press and hold **INPUT ATT** so that the **INPUT ATT** indicator lights up on the display.

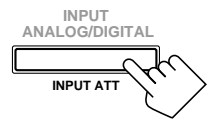

- Each time you press and hold the button, the Input Attenuator mode turns on (“**INPUT ATT ON**”) or off (“**INPUT NORMAL**”).

Notes:

- This function is available only for the sources connected using the analog terminals.
- This function takes effect when the DSP mode is in use.
- When selecting “**DVD MULTI**” as the source, this effect does not work.

Adjusting the Subwoofer Output Level

You can adjust the subwoofer output level if you have selected “**YES**” for the “**SUBWOOFER**” (see page 14).

Once it has been adjusted, the receiver memorizes the adjustment.

Before you start, remember...

- There is a time limit in doing the following steps. If the setting is canceled before you finish, start from step 1 again.
- When the front speakers are all deactivated, the subwoofer level cannot be adjusted.

On the front panel:

1. Press **ADJUST** repeatedly until “**SUBWFR LEVEL**” appears on the display.

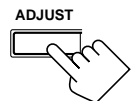

The display changes to show the current setting.

2. Press **CONTROL UP ▲/DOWN ▼** to adjust the subwoofer output level (+10 dB to –10 dB).

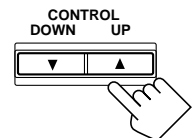

From the remote control:

1. Press **SOUND**.

The 10 keys are activated for sound adjustments.

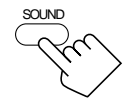

2. Press **SUBWOOFER +/-** to adjust the subwoofer output level (+10 dB to –10 dB).

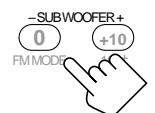

Basic Settings

Some of the following settings are required after connecting and positioning your speakers in your listening room, while others will make operations easier.

Recording a Source

For analog-to-analog recording

You can record any analog source through the receiver to —

- the cassette deck (or CD recorder) connected to the TAPE/CDR jacks, and
 - the VCR connected to the VCR jacks
- at the same time.

For digital-to-digital recording

You can record the currently selected digital input through the receiver to a digital recording device connected to the DIGITAL OUT terminal.

Notes:

- Analog-to-digital and digital-to-analog recordings are not possible.
- The output volume level, bass boost (see page 12), tone adjustment (see page 12), and DSP modes (see page 23) cannot affect the recording.
- The test tone signal (see pages 26 and 27) does not come out through the DIGITAL OUT terminal.

Adjusting the Front Speaker Output Balance

If the sounds you hear from the front right and left speakers are unequal, you can adjust the speaker output balance.

Before you start, remember....

- There is a time limit in doing the following steps. If the setting is canceled before you finish, start from step 1 again.

On the front panel ONLY:

1. Press **ADJUST** repeatedly until “L/R BALANCE” appears on the display.

The display changes to show the current setting.

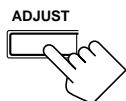

2. Press **CONTROL UP ▲/DOWN ▼** to adjust the balance.

- Pressing **CONTROL UP ▲** decreases the left channel output from CNTR (Center) to -21.
- Pressing **CONTROL DOWN ▼** decreases the right channel output from CNTR (Center) to -21.

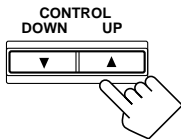

Changing the Source Name

When you have connected a CD recorder to the TAPE/CDR jacks or the DBS tuner to the TV SOUND/DBS jacks on the rear panel, change the source name which will be shown on the display when you select the CD recorder or DBS tuner as the source.

On the front panel ONLY:

When changing the source name from “TAPE” to “CDR”:

- Press and hold **TAPE/CDR/SOURCE NAME** to assign “CDR.”

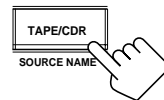

When changing the source name from “TV SOUND” to “DBS”:

- Press and hold **TV SOUND/DBS/SOURCE NAME** to assign “DBS.”

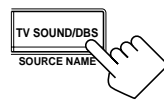

To change the source name to “TAPE” or “TV SOUND,” repeat the same procedure above — press and hold TAPE/CDR/SOURCE NAME to select “TAPE” or TV SOUND/DBS/SOURCE NAME to select “TV SOUND.”

Note:

Without changing the source name, you can still use the connected components. However, there may be some inconvenience.

- “TAPE” or “TV SOUND” will appear on the display when you select the CD recorder or DBS tuner.
- You cannot use the digital input (see page 16) for the CD recorder.
- You cannot use the COMPU LINK remote control system (see page 31) to operate the CD recorder.

Setting the Subwoofer Information

Register whether you have connected a subwoofer or not.

Before you start, remember....

- There is a time limit in doing the following steps. If the setting is canceled before you finish, start from step 1 again.

On the front panel ONLY:

1. Press **SETTING** repeatedly until **"SUBWOOFER"** appears on the display.

The display changes to show the current setting.

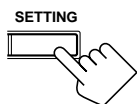

2. Press **CONTROL UP ▲/DOWN ▼** to register whether you have connected a subwoofer or not.

- Each time you press the button, the subwoofer setting alternates between "YES" and "NO."

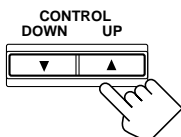

YES: Select this when a subwoofer is used. [SWFR] lights up on the display (see page 10).

NO: Select this when no subwoofer is used.

Setting the Speakers for the DSP Modes

To obtain the best possible surround sound of the DSP modes, you have to register the information about the speakers arrangement after all connections are completed.

Before you start, remember....

- There is a time limit in doing the following steps. If the setting is canceled before you finish, start from step 1 again.

Front, Center, and Rear Speaker Setting

Register the sizes of all the connected speakers.

- When you change your speakers, you need to register the information about the speakers again.

On the front panel ONLY:

1. Press **SETTING** repeatedly until **"FRONT SPK"** (Front Speaker), **"CENTER SPK"** (Center Speaker) or **"REAR SPK"** (Rear Speaker) appears on the display.

The display changes to show the current setting.

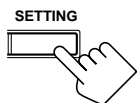

2. Press **CONTROL UP ▲/DOWN ▼** to select the appropriate item about the speaker selected in the above step.

- Each time you press the button, the display changes to show the following:

→ LARGE ↔ SMALL ↔ NO ←

LARGE: Select this when the speaker size is relatively large.

SMALL: Select this when the speaker size is relatively small.

NO: Select this when you have not connected a speaker. (Not selectable for the front speakers)

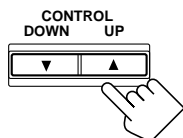

3. Repeat steps 1 and 2 to select the appropriate items for the other speakers.

Notes:

- Keep the following comment in mind as reference when adjusting.
 - If the size of the cone speaker unit built in your speaker is greater than 4 3/4 inches (12 cm), select "LARGE," and if it is smaller than 4 3/4 inches (12 cm), select "SMALL."
- If you have selected "NO" for the subwoofer setting, you can only select "LARGE" for the front speaker setting.
- If you have selected "SMALL" for the front speaker setting, you cannot select "LARGE" for the center and rear speaker settings.

Center Delay Time Setting

Register the delay time of the sound from the center speaker, comparing to that of the sound from the front speakers.

If the distance from your listening point to the center speaker is equal to that to the front speakers, select 0 msec. As the distance to the center speaker becomes shorter, the delay time increases.

- 1 msec increase (or decrease) in delay time corresponds to 1 13/16 inches (30 cm) decrease (or increase) in distance.
- When shipped from the factory, delay time is set to 0 msec.

On the front panel ONLY:

1. Press **SETTING** repeatedly until **"CENTER DELAY"** appears on the display.

The display changes to show the current setting.

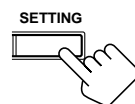

2. Press **CONTROL UP ▲/DOWN ▼** to select the delay time of the center speaker output.

- Press **CONTROL UP ▲** to increase the delay time from 0 msec ("C_DELAY 0MS") to 5 msec ("C_DELAY 5MS").
- Press **CONTROL DOWN ▼** to decrease the delay time from 5 msec ("C_DELAY 5MS") to 0 msec ("C_DELAY 0MS").

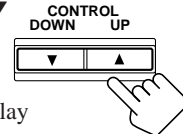

Notes:

- Center delay time is not valid for the DVD MULTI playback mode.
- You cannot adjust the center delay time when you have set "CENTER SPK" to "NO."

Rear Delay Time Setting

Register the delay time of the sound from the rear speakers, comparing to that of the sound from the front speakers.

If the distance from your listening point to the rear speakers is equal to that to the front speakers, select 0 msec. As the distance to the rear speakers becomes shorter, the delay time increases.

- 1 msec increase (or decrease) in delay time corresponds to 1 13/16 inches (30 cm) decrease (or increase) in distance.
- Rear delay time for Dolby Digital and DTS Digital Surround is to be set to 5 msec.
- When shipped from the factory, delay time is set to 5 msec.

On the front panel ONLY:

1. Press **SETTING** repeatedly until **"REAR DELAY"** appears on the display.

The display changes to show the current setting.

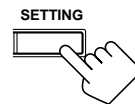

Continued to the next page.

2. Press CONTROL UP ▲/DOWN ▼ to select the delay time of the rear speaker output.

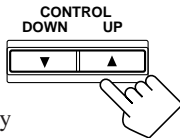

- Press CONTROL UP ▲ to increase the delay time from 0 msec (“R_DELAY 0MS”) to 15 msec (“R_DELAY 15MS”).
- Press CONTROL DOWN ▼ to decrease the delay time from 15 msec (“R_DELAY 15MS”) to 0 msec (“R_DELAY 0MS”).

Notes:

- Rear delay time is not valid for the DVD MULTI playback mode.
- You cannot adjust the rear delay time when you have set “REAR SPK” to “NO.”

Crossover Frequency Setting

Small speakers cannot reproduce the bass sound very well. So, if you have used a small speaker for any of the front, center, and rear channels, this receiver automatically reallocate the bass elements, originally assigned to the channel for which you have connected the small speaker, to another channel (for which you have connected the large speaker).

To use this function properly, you need to set the crossover frequency level according to the size of the small speaker connected.

- If you have selected “LARGE” for all speakers (see page 14), this function is set to “OFF” and cannot be adjusted.

On the front panel ONLY:

1. Press SETTING repeatedly until “CROSSOVER FRQ” (Crossover Frequency) appears on the display.

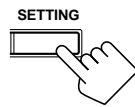

The display changes to show the current setting.

2. Press CONTROL UP ▲/DOWN ▼ to select the crossover frequency level according to the size of the small speaker connected.

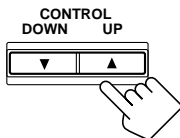

- Each time you press the button, the display changes to show the following:

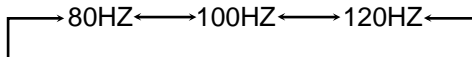

- Use the following comments as reference when adjusting.

80HZ: Select this when the cone speaker unit built in the speaker is about 4 3/4 inches (12 cm).

100HZ: Select this when the cone speaker unit built in the speaker is about 3 15/16 inches (10 cm).

120HZ: Select this when the cone speaker unit built in the speaker is about 3 3/16 inches (8 cm).

Note:

Crossover frequency is not valid for the DVD MULTI playback mode and HEADPHONE mode.

Low Frequency Effect Attenuator Setting

If the bass sound is distorted while playing back a source using Dolby Digital or DTS Digital Surround, follow the procedure below.

On the front panel ONLY:

1. Press SETTING repeatedly until “LFE ATT” (Low Frequency Effect Attenuator) appears on the display.

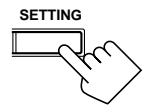

The display changes to show the current setting.

2. Press CONTROL UP ▲/DOWN ▼ to select the low frequency effect attenuator level.

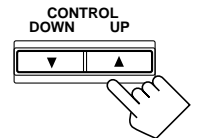

- Each time you press the button, the display changes to show the following:

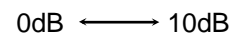

0dB: Normally select this.

10dB: Select this when the bass sound is distorted.

Notes:

- Low frequency effect attenuator is not valid for the DVD MULTI playback mode.
- This function takes effect only when the subwoofer (LFE) signals come in, (with “SUBWOOFER” set to “YES.”)

Dynamic Range Compression Setting

You can compress the dynamic range (difference between maximum sound and minimum sound) of the reproduced sound. This is useful when enjoying surround sound at night.

- This function takes effect only when playing back a source using Dolby Digital.

On the front panel ONLY:

1. Press SETTING repeatedly until “D_RANGE COMP” (Dynamic Range Compression) appears on the display.

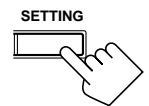

The display changes to show the current setting.

2. Press CONTROL UP ▲/DOWN ▼ to select the appropriate item about the compression level.

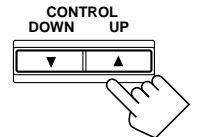

- Each time you press the button, the display changes to show the following:

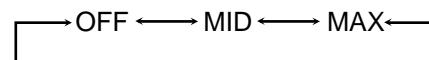

OFF: Select this when you want to enjoy surround with its full dynamic range. (No effect applied.)

MID: Select this when you want to reduce the dynamic range a little. (Factory setting.)

MAX: Select this when you want to apply the compression effect fully. (Useful at night.)

Note:

Dynamic Range Compression is not valid for the DTS Digital Surround and DVD MULTI playback mode.

Digital Input (DIGITAL IN) Terminal Setting

When you use the digital input terminals, you have to register what components are connected to which terminals (DIGITAL IN 1/2/3/4).

Before you start, remember....

- There is a time limit in doing the following steps. If the setting is canceled before you finish, start from step 1 again.

On the front panel ONLY:

To set the DIGITAL 1 terminal

1. Press **SETTING** repeatedly until "COAX DIG IN" appears on the display.

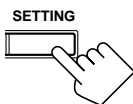

The display changes to show the current setting.

2. Press **CONTROL UP ▲/DOWN ▼** to select the appropriate digital terminal setting.

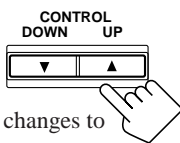

- Each time you press the button, the display changes to show the following:

1 DVD ⇄ 1 CDR ⇄ 1 TV (or 1 DBS*) ⇄ 1 CD ⇄
(back to the beginning)

* If you have changed the source name from "TV SOUND" to "DBS," "DBS" appears (see page 13.)

When the **DIGITAL 1** terminal is set, the **DIGITAL 2/3/4** terminal is automatically set as follows:

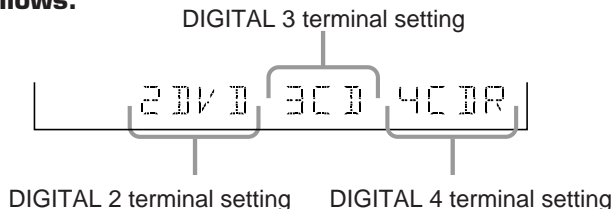

When the **DIGITAL 1** is set to "DVD"

2 CD 3 TV (or DBS*) 4 CDR

When the **DIGITAL 1** is set to "CDR"

2 DVD 3 CD 4 TV (or DBS*)

When the **DIGITAL 1** is set to "TV" or "DBS"

2 DVD 3 CD 4 CDR

When the **DIGITAL 1** is set to "CD"

2 DVD 3 TV (or DBS*) 4 CDR

* If you have changed the source name from "TV SOUND" to "DBS," "DBS" appears (see page 13.)

Notes:

- When shipped from the factory, the DIGITAL IN terminals can be used as the digital input for the following components.
 - DIGITAL 1 (coaxial): For DVD player
 - DIGITAL 2 (optical): For CD player
 - DIGITAL 3 (optical): For digital TV broadcast tuner
 - DIGITAL 4 (optical): For CDR
- When using the DIGITAL 4 terminal for the CD recorder, you need to select "CDR" as the source name. (See page 13.)

Selecting the Analog or Digital Input Mode

When you have connected digital source components, you need to select the input mode correctly according to the connection you made.

Before you start, remember...

- The digital input (**DIGITAL IN**) terminal setting should be correctly done for the sources you want to select the digital input mode for. Without setting this digital input terminal correctly, you cannot change the input mode from analog input to digital input even if you follow the procedure below.

On the front panel:

1. Press one of the source selecting buttons (DVD, TV SOUND/DBS, CD, or TAPE/CDR)* for which you want to change the input mode.

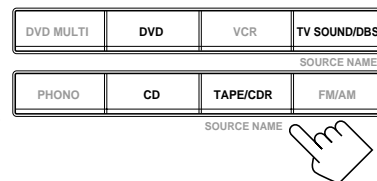

Note:

* Among the sources listed above, you can select the digital input only for the sources which you have selected the digital input terminals for. (See "Digital Input (DIGITAL IN) Terminal Setting.")

2. Press **INPUT ANALOG/DIGITAL** to change the input mode.

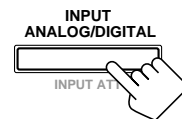

- Each time you press the button, the input mode changes as follows:

AUTO ↔ ANALOG
(Digital)

AUTO: Select this for the digital input mode. The receiver automatically detects the incoming signal format. (The DIGITAL AUTO indicator lights up on the display, and the digital signal indicator for the detected signals also light up.)*

ANALOG: Select this for the analog input mode.

* The followings are the analog/digital signal indicators on the display to indicate what type of the signal comes into the receiver.

DIGITAL AUTO : Lights up when "AUTO" is selected as the digital input mode.

ANALOG : Lights up when the analog input is selected.

LINEAR PCM : Lights up when Linear PCM signals come in.

DIGITAL: Lights up when Dolby Digital signals come in.

dts : Lights up when DTS Digital Surround signals come in.

Continued to the next page.

When playing a software encoded with the DTS Digital Surround, "AUTO" may not work properly and the following symptoms may occur:

- Sound does not come out at the beginning of playback.
- Noise comes out while using the searching or skipping function.

In this case, press CONTROL UP ▲/DOWN ▼ to select "DTS" while "AUTO" is lit on the display.

- Each time you press the button, the input mode changes as follows:

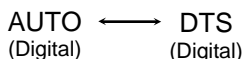

Note:

When you turn off the power or select another source, "DTS" setting is canceled and the digital input mode is automatically reset to "AUTO."

To change the input mode back to analog input, select "ANALOG" by pressing INPUT ANALOG/DIGITAL again.

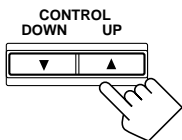

From the remote control:

1. Press the source selecting button (DVD, CD, TV/DBS, or TAPE/CDR)* for which you want to change the input mode.

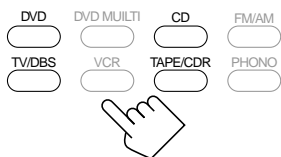

Note:

* Among the sources listed above, you can select the digital input only for the sources which you have selected the digital input terminals for. (See "Digital Input (DIGITAL IN) Terminal Setting.")

2. Press ANALOG/DIGITAL to change the input mode.

- Each time you press the button, the input mode changes as follows:

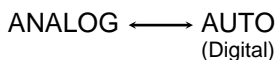

When playing a software encoded with the DTS Digital Surround, "AUTO" may not work properly. In this case, press CONTROL UP ▲/DOWN ▼ on the front panel to select "DTS." (See above.)

Note:

You can only select "ANALOG" and "AUTO" using the remote control.



Storing the Basic Settings and Adjustments

You can assign and store different sound settings for each different playing source. By using this function, you do not have to change the settings every time you change the source. The stored settings for the newly selected source are automatically recalled.

The following can be stored for each source:

- Bass boost (see page 12)
- Tone adjustment (see page 12)
- Input attenuator mode (see page 12)
- Subwoofer output level (see page 12)
- Balance (see page 13)
- DSP modes
 - Surround mode (see page 26)
 - DAP mode (see page 28)
- DVD MULTI playback mode (see page 30)

The above settings are stored automatically in the following cases:

- When you turn on the power.
- When you change the source.
- When you assign the source name.

Notes:

- You cannot assign and store different settings for digital input mode and analog input mode.
- The DSP modes and DVD MULTI playback mode cannot be used at the same time.
- If the source is FM or AM (MW/LW), you can assign a different setting for each band.

Using the Sleep Timer

Using the Sleep Timer, you can fall asleep to music and know the receiver will turn off by itself rather than play all night.

From the remote control ONLY:

Press SLEEP repeatedly.

The SLEEP indicator lights up on the display, and the shut-off time changes as follows (in minutes):

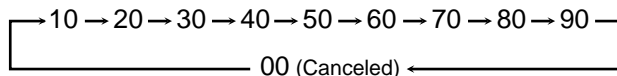

When the shut-off time comes

The receiver turns off automatically.

To check or change the time remaining until the shut-off time

Press SLEEP once.

The remaining time until the shut-off time appears in minutes.

- To change the shut-off time, press SLEEP repeatedly.

To cancel the Sleep Timer

Press SLEEP repeatedly until "SLEEP 00 MIN." appears on the display. (The SLEEP indicator goes off.)

- Turning off the power also cancels the Sleep Timer.

Receiving Radio Broadcasts

You can browse through all the stations or use the preset function to go immediately to a particular station.

Tuning in Stations Manually

On the front panel:

1. Press FM/AM to select the band (FM or AM — MW/LW).

The last received station of the selected band is tuned in.

- Each time you press the button, the band alternates between FM and AM (MW/LW).

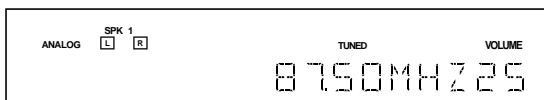
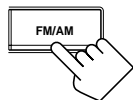

2. Press FM/AM TUNING ▲/▼ until you find the frequency you want.

- Pressing FM/AM TUNING ▲ increases the frequency.
- Pressing FM/AM TUNING ▼ decreases the frequency.

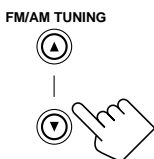

From the remote control:

1. Press FM/AM to select the band.

- Each time you press the button, the band alternates between FM and AM (MW/LW).



2. Press TUNING +/- until you find the frequency you want.

- Pressing TUNING + increases the frequency.
- Pressing TUNING – decreases the frequency.

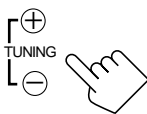

Notes:

- When a station of sufficient signal strength is tuned in, the TUNED indicator lights up on the display.
- When an FM stereo program is received, the STEREO indicator also lights up.

Using Preset Tuning

Once a station is assigned to a channel number, the station can be quickly tuned. You can preset up to 30 FM and 15 AM (MW/LW) stations.

To store the preset stations

Before you start, remember...

- There is a time limit in doing the following steps. If the setting is canceled before you finish, start from step 1 again.

On the front panel ONLY:

1. Tune in the station you want to preset (see “Tuning in Stations Manually”).

- If you want to store the FM reception mode for this station, select the FM reception mode you want. See “Selecting the FM Reception Mode” on page 19.

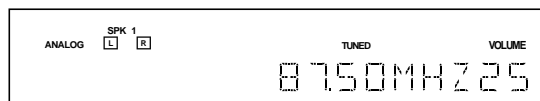

2. Press MEMORY.

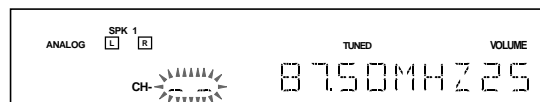
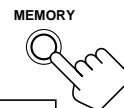

“CH-” appears and the channel number position starts flashing on the display for about 5 seconds.

3. Press FM/AM PRESET ▲/▼ to select a channel number while the channel number position is flashing.

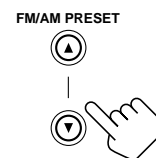

Note:

You can use the 10 keys on the remote control to select the preset number. When using the 10 keys, be sure that they are activated for the tuner, not for the CD and others. (See page 32.)

4. Press MEMORY again while the selected channel number is flashing on the display.

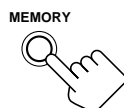

The selected channel number stops flashing.

The station is assigned to the selected channel number.

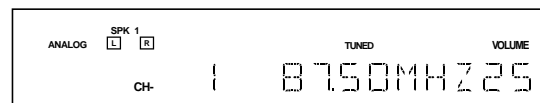

5. Repeat steps 1 to 4 until you store all the stations you want.

To erase a stored preset station

Storing a new station on a used number erases the previously stored one.

To tune in a preset station

On the front panel:

1. Press FM/AM to select the band (FM or AM — MW/LW).
The last received station of the selected band is tuned in.
2. Press FM/AM PRESET ▲/▼ until you find the channel you want.
 - Pressing FM/AM PRESET ▲ increases the channel numbers.
 - Pressing FM/AM PRESET ▼ decreases the channel numbers.

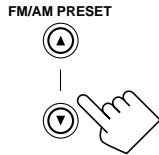
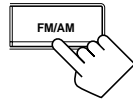

From the remote control:

1. Press FM/AM.
 - Each time you press the button, the band alternates between FM and AM (MW/LW).
2. Press the 10 keys to select a preset channel number.
 - For channel number 5, press 5.
 - For channel number 15, press +10 then 5.
 - For channel number 20, press +10 then 10.
 - For channel number 30, press +10, +10, then 10.

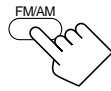

Note:

When you use the 10 keys on the remote control, be sure that they are activated for the tuner, not for the CD and others. (See page 32.)

Selecting the FM Reception Mode

When an FM stereo broadcast is hard to receive or noisy

You can change the FM reception mode while receiving an FM broadcast.

- You can store the FM reception mode for each preset station.

Press FM MODE on the front panel or on the remote control.

- Each time you press the button, the FM reception mode alternates between “AUTO” and “MONO.”

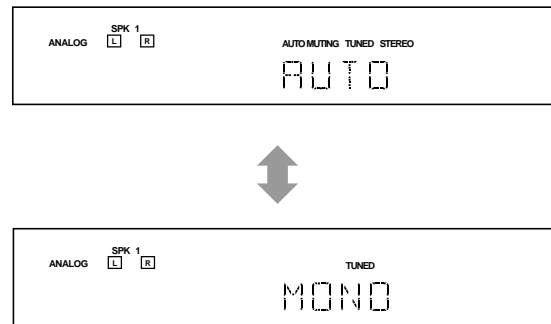
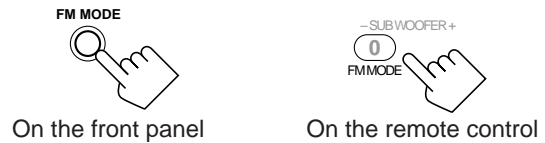

AUTO: When a program is broadcasted in stereo, you will hear stereo sound; when in monaural, you will hear monaural sounds. This mode is also useful to suppress static noise between stations. The AUTO MUTING indicator lights up on the display.

MONO: Reception will be improved although you will lose the stereo effect. In this mode, you will hear noise while tuning into the stations. The AUTO MUTING indicator goes off from the display.

Note:

When using the FM MODE button on the remote control, be sure that the 10 keys are activated for the tuner, not for the CD and others. (See page 32.)

Using the RDS (Radio Data System) to Receive FM Stations

RDS allows FM stations to send an additional signal along with their regular program signals. For example, the stations send their station names, as well as information about what type of program they broadcast, such as sports or music, etc.

When tuned to an FM station which provides the RDS service, the RDS indicator lights up on the display.

With the receiver, you can receive the following types of RDS signals.

PS (Program Service):	Shows commonly known station names
PTY (Program Type):	Shows types of broadcast programs
RT (Radio Text):	Shows text messages the station sends
EON (Enhanced Other Network):	See page 21.

Notes:

- RDS is not available for AM (MW/LW) broadcasts.
- RDS may not operate correctly if the station tuned is not transmitting RDS signal properly or if the signal strength is weak.

What information can RDS signals provide?

You can see the RDS signals the station sends on the display.

To show the RDS signals

Press **DISPLAY MODE** on the front panel or **DISPLAY** on the remote control while listening to an FM station.

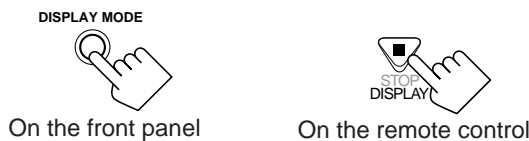

- Each time you press the button, the display changes to show you the following information:

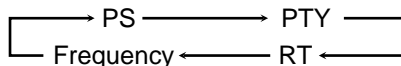

PS (Program Service):

While searching, "PS" appears and then the station names will be displayed. "NO PS" appears if no signal is sent.

PTY (Program Type):

While searching, "PTY" appears and then the type of the broadcast program will be displayed. "NO PTY" appears if no signal is sent.

RT (Radio Text):

While searching, "RT" appears and then text messages the station sends will be displayed. "NO RT" appears if no signal is sent.

Frequency:

Station frequency (non-RDS service)

About characters shown on the display

When the display shows PS, PTY, or RT signals, the following characters are used.

- The display cannot differentiate upper case and lower case letters and always uses upper case letters.
- The display cannot show accented letters, "A," for instance, may stand for accented "A's" like "Ä, Ä, Ä, Á, À, and Â."

Notes:

- When pressing **DISPLAY** on the remote control, make sure that you have selected FM station using the remote control. If not, the **DISPLAY** button does not work for tuner operation. (Pressing **FM/AM** activates the remote control for tuner operation.)
- If searching finishes at once, "PS," "PTY," and "RT" will not appear on the display.

Searching for a Program by PTY Codes

One of the advantages of the RDS service is that you can locate a particular kind of program from the preset channels (see page 18) by specifying the PTY codes.

To search for a program using the PTY codes

Before you start, remember...

- The PTY Search is only applicable to preset stations.
- To stop searching any time during the process, press **PTY SEARCH** while searching.
- There is a time limit in doing the following steps. If the setting is canceled before you finish, start from step 1 again.
- When pressing the buttons on the remote control, make sure that you have selected the FM station using the remote control. If not, the RDS operation buttons do not work for RDS operation. (Pressing **FM/AM** activates the remote control for RDS operation.)

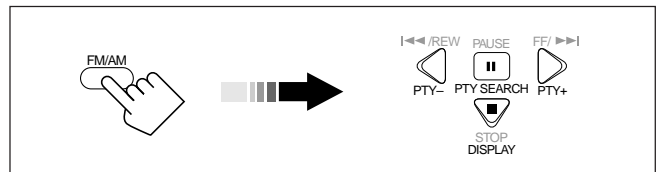

On the front panel:

1. Press **PTY SEARCH** while listening to an FM station. "PTY SELECT" flashes on the display.



2. Press **CONTROL UP ▲/DOWN ▼** until the PTY code you want appears on the display, while "PTY SELECT" is flashing.

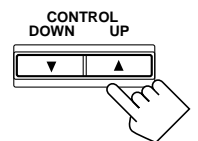

The display gives you the PTY codes described on page 21.

3. Press **PTY SEARCH** again, while the PTY code selected in the previous step is still on the display.



While searching, "SEARCH" and the selected PTY code alternate on the display.

The receiver searches 30 preset FM stations, stops when it finds the one you have selected, and tunes in that station.

To continue searching after the first stop

Press **PTY SEARCH** again while the indications on the display are flashing.

If no program is found, "NOTFOUND" appears on the display.

From the remote control:

1. Press **PTY SEARCH** while listening to an FM station. "PTY SELECT" flashes on the display.



2. Press and hold **PTY +** or **PTY -** until the **PTY** code you want appears on the display, while "PTY SELECT" is flashing.

The display gives you the PTY codes described below.



3. Press **PTY SEARCH** again, while the **PTY** code selected in the previous step is still on the display.

While searching, "SEARCH" and the selected PTY code alternate on the display. The receiver searches 30 preset FM stations, stops when it finds the one you have selected, and tunes in that station.



To continue searching after the first stop

Press **PTY SEARCH** again while the indications on the display are flashing.

If no program is found, "NOTFOUND" appears on the display.

Switching to a Broadcast Program of Your Choice Temporarily

Another convenient RDS service is called "EON (Enhanced Other Network)."

The EON indicator lights up while receiving an FM station with the EON code. (The EON indicator also lights up while receiving an AM station but the EON function will not work.)

This allows the receiver to switch temporarily to a broadcast program of your choice (NEWS, TA, and/or INFO) from a different station except in the following cases:

- When you are listening to non-RDS stations (all AM — MW/LW and some FM stations).
- When the last received FM station is a non-RDS station.
- When the receiver is in standby mode.

Before you start, remember...

- The EON function is only applicable to preset stations.

On the front panel ONLY:

1. Press **EON** so that the last selected program type appears on the display.



The receiver enters EON standby mode. When the receiver is in EON standby mode, the receiver is ready to receive the EON data (TA/NEWS/INFO) you select.

2. Press **TA/NEWS/INFO** until the program type you want appears on the display.



- Each time you press the button, the display changes to show the following:

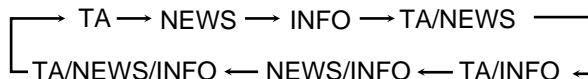

TA: Traffic Announcement in your area.

NEWS: News.

INFO: Program the purpose of which is to impart advice in the widest sense.

PTY codes



CASE 1**If there is no station broadcasting the program you have selected**

The receiver continues playing the current source (all sources except AM — MW/LW).



When a station starts broadcasting the program you have selected, the receiver automatically switches to the station. The indicator of received PTY code starts flashing.



When the program is over, the receiver goes back to the previously selected source, but still remains in EON standby mode. The indicator of received PTY code stops flashing and remains lit.

CASE 2**If there is a station broadcasting the program you have selected**

The receiver changes the source (all sources except AM — MW/LW), and tunes in the station. The indicator of received PTY code starts flashing.



When the program is over, the receiver goes back to the previously selected source, but still remains in EON standby mode. The indicator of received PTY code stops flashing and remains lit.

CASE 3**If the FM station you are listening to is broadcasting the program you have selected**

The receiver continues to receive the station, but the indicator of received PTY code starts flashing.



When the program is over, the indicator of received PTY code stops flashing and remains lit, but the receiver remains in EON standby mode.

When an emergency broadcast (ALARM signal) is sent from an FM station:

The receiver automatically tunes in the station except in the following cases:

- When you are listening to non-RDS stations (all AM — MW/LW and some FM stations).
- When the receiver is in standby mode.

While receiving an emergency broadcast, “ALARM” appears on the display.

The TEST signal is used for equipment test — whether it can receive the ALARM signal correctly.

The TEST signal makes the receiver work in the same way as the ALARM signal does. If the TEST signal is received, the receiver automatically switches to the station broadcasting the TEST signal. While receiving the test signal, “TEST” appears on the display.

Notes:

- EON data sent from some stations may not be compatible with this receiver.
- In EON standby mode, if you carry out synchronized recording (see page 31), EON standby mode is canceled temporarily. The receiver goes back to EON standby mode again when you have finished that operation.
- The EON mode only works when receiving an FM station with the EON code. (The EON indicator lights up while receiving an AM station but the EON function will not work.)
- While listening to a program tuned in by the EON function, you cannot use source selecting buttons and PTY SEARCH button.

CAUTION:

When the source alternates intermittently between the station tuned in by the EON function and the currently selected source, press EON to cancel the EON function.

If you do not press the button, the currently tuned station is received finally, and the indication of the EON program type flashing on the display disappears.

To stop listening to the program selected by EON

Press EON so that the program type (TA/NEWS/INFO) indicator goes off from the display. The receiver enters EON off mode and goes back to the previously selected source.

- Each time you press EON, the EON mode alternates between standby mode and off mode.

Using the DSP Modes

The built-in Surround Processor provides two types of the DSP (Digital Signal Processor) mode — Surround mode and DAP (Digital Acoustic Processor) mode.

What are the DSP Modes?

Surround modes

With this receiver, you can use three types of the Surround mode.

Following modes cannot be used when only the front speakers are connected to this receiver (without the rear speakers or center speaker).

Dolby Surround (Dolby Digital and Dolby Pro Logic)*

Used to watch the soundtracks of software encoded with Dolby Digital (bearing the mark ) or with Dolby Surround (bearing the mark ) .

Dolby Surround encoding format records the left front channel, right front channel, center channel, and rear channel (total 4 channels) signals into 2 channels. The Dolby Pro Logic decoder built in this receiver decodes these 2 channel signals into original 4 channel signals — matrix-based multichannel reproduction, and allows you to enjoy the realistic stereo sounds in your listening room.

On the other hand, Dolby Digital encoding method (so called discrete 5.1 channel digital audio format) records and compresses the left front channel, right front channel, center channel, left rear channel, right rear channel, and LFE channel (total 6 channels, but LFE channel is counted as 0.1 channel, therefore called 5.1 channels) signals digitally. Each channel is completely independent from other channel signals to avoid interference, therefore, you can obtain much better sound quality with much stereo and surround effects.

The Dolby Digital decoder built in this receiver can create much more realistic sound field in your listening room. You may feel as if you were in a real theater.

In addition, Dolby Digital enables stereo rear sounds, and sets the cutoff frequency of the rear treble at 20 kHz, compared to 7 kHz for Dolby Pro Logic. These facts enhance the sound movement and being-there feelings much more than Dolby Pro Logic.

- To enjoy the software encoded with Dolby Digital, you must connect the source component using the digital terminal on the rear of this receiver. (See page 8.)

DTS Digital Surround**

DTS Digital Surround is another discrete 5.1 channel digital audio format available on CD, LD, and DVD software.

Compared to Dolby Digital, audio compression rate is relatively low. This fact allows DTS Digital Surround format to add breadth and depth to the reproduced sounds. As a result, DTS Digital Surround features natural, solid and clear sound.

- To enjoy the software encoded with DTS Digital Surround, you must connect the source component using the digital terminal on the rear of this receiver. (See page 8.)

JVC Theater Surround

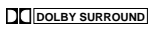
In order to reproduce a more realistic sound field in your listening room while playing soundtracks of software encoded with Dolby Surround (bearing the mark ) , you can use JVC Theater Surround.

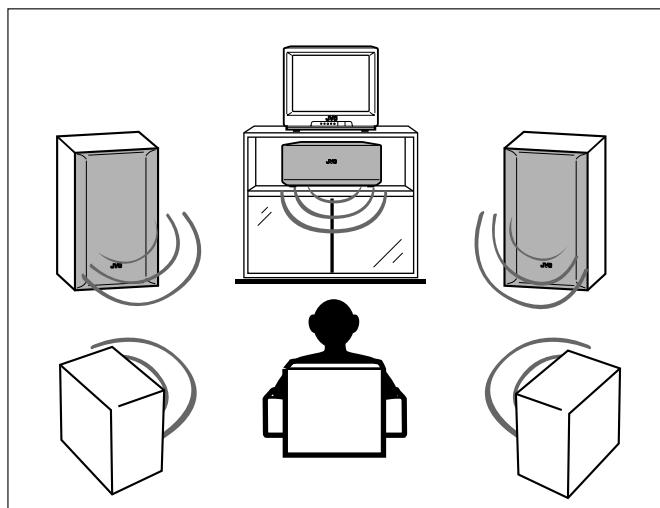

Notes:

- The DSP modes have no effect on monaural sources.
- When you select "DVD MULTI" as the source to play, you cannot select or adjust the DSP modes.
- The PRO LOGIC indicator lights up when the Dolby Pro Logic decoder built in this receiver is activated.

* Manufactured under license from Dolby Laboratories. "Dolby," "Pro Logic," and the double-D symbol are trademarks of Dolby Laboratories. Confidential Unpublished Works. ©1992–1997 Dolby Laboratories, Inc. All rights reserved.

** Manufactured under license from Digital Theater Systems, Inc. US Pat. No. 5,451,942 and other world-wide patents issues and pending. "DTS" and "DTS Digital Surround" are trademarks of Digital Theater Systems, Inc. ©1996 Digital Theater Systems, Inc. All rights reserved.

DAP modes

In order to reproduce a more acoustic sound field in your listening room while playing soundtracks of stereo sources, you can use DAP modes. **This mode can be used when the front speakers and the rear speakers are connected to this receiver (without respect to the center speaker connection).**

You can select one of the following to your preference.

LIVE CLUB:	Gives the feeling of a live music club with a low ceiling.
DANCE CLUB:	Gives a throbbing bass beat.
HALL:	Gives clear vocal and the feeling of a concert hall.
PAVILION:	Gives the spacious feeling of a pavilion with a high ceiling.

DVD MULTI Playback Mode

This receiver provides the DVD MULTI playback mode for reproducing the analog discrete 5.1 channel output mode of the DVD player or other equipment.

You can adjust the DVD MULTI playback mode while playing back a video software such as a DVD using the analog discrete 5.1 channel output mode.

- For the DVD MULTI playback mode connection, see page 7.
- For details on the DVD MULTI playback mode, see page 30.

Reproducing the Sound Field

The sound heard in a concert hall or club consists of direct sound and indirect sound — early reflections and reflections from behind. Direct sounds reach the listener directly without any reflection. On the other hand, indirect sounds are delayed by the distances of the ceiling and walls. These direct sounds and indirect sounds are the most important elements of the acoustic surround effects.

JVC Theater Surround and DAP modes can create these important elements, and give you a real “being there” feeling.

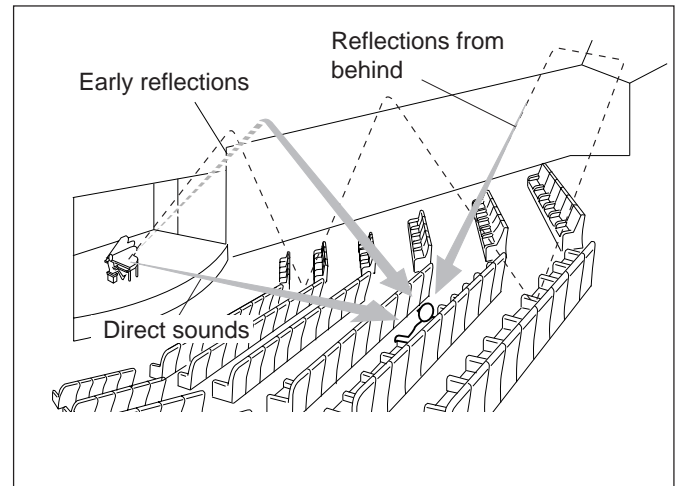

Available DSP modes according to the input mode

○: Possible ×: Impossible

BUTTON		SURROUND ON/OFF	DSP MODE					
MODE		SURROUND ON	THEATER	LIVE CLUB	DANCE CLUB	HALL	PAVILION	DSP OFF (SURROUND OFF)
INPUT	ANALOG (2 CH)	○ (DOLBY PRO LOGIC)	○	○	○	○	○	○
	DVD MULTI (ANALOG 5.1 CH)	×	×	×	×	×	×	×
	LINEAR PCM	○ (DOLBY PRO LOGIC)	○	○	○	○	○	○
	DOLBY DIGITAL	○ *1 (DOLBY DIGITAL)	×	×	×	×	×	○
	DTS	○ *2 (DTS SURROUND)	×	×	×	×	×	○

*1 When 2 channel signal comes in, DOLBY PRO LOGIC is selected. When other signals come in, DOLBY DIGITAL is selected.

*2 When 2 channel signal comes in, DOLBY PRO LOGIC is selected. When other signals come in, DTS SURROUND is selected.

Available DSP Modes According to the Speaker Arrangement

Available DSP modes will vary depending on how many speakers are used with this receiver.

Make sure that you have set the speaker information correctly (see page 14).

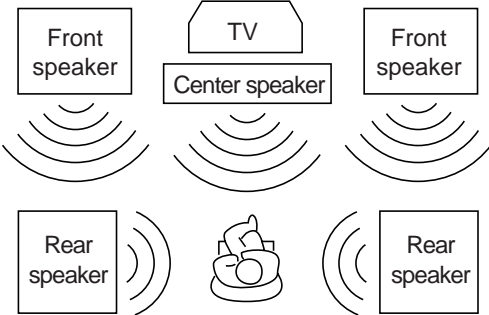
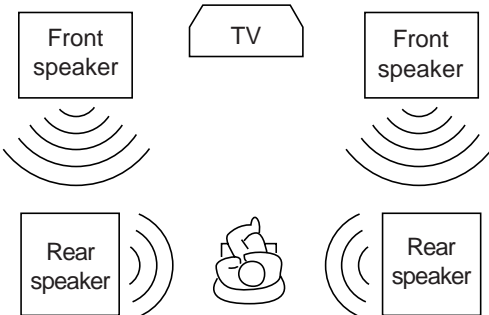
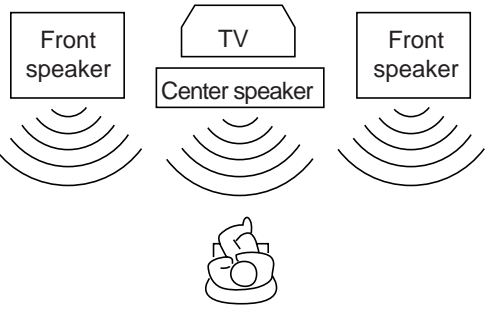
Speaker arrangements	Available DSP modes
	<p>By pressing SURROUND ON/OFF, the surround mode turns on and off:</p> <ul style="list-style-type: none"> • SURROUND ON (PRO LOGIC, DOLBY DIGITAL or DTS SURROUND) • SURROUND OFF (DSP mode is canceled) <p>By pressing DSP MODE, the DSP modes change as follows:</p> <ul style="list-style-type: none"> • THEATER • LIVE CLUB • DANCE CLUB • HALL • PAVILION • DSP OFF (DSP mode is canceled)
	
	<p>By pressing SURROUND ON/OFF, the surround mode turns on and off:</p> <ul style="list-style-type: none"> • SURROUND ON (PRO LOGIC, DOLBY DIGITAL or DTS SURROUND) • SURROUND OFF (DSP mode is canceled) <p>By pressing DSP MODE, the DSP modes change as follows:</p> <ul style="list-style-type: none"> • THEATER • DSP OFF (DSP mode is canceled)

Adjusting the Surround Modes

Once you have adjusted the Surround modes, the adjustment is memorized for each Surround mode.



Dolby and DTS Surround adjustments

Before you start, remember...

- Make sure that you have set the speaker information correctly (see page 14).
- There is a time limit in doing the following steps. If the setting is canceled before you finish, start from step 3 again.
- You cannot adjust the rear speaker output levels when you have set "REAR SPK" to "NO." See page 14.
- You cannot adjust the center speaker output level when you have set "CENTER SPK" to "NO." See page 14.

From the remote control:

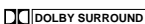
1. Select and play a sound source.

- To enjoy Dolby Pro Logic, play back a software encoded with Dolby Surround and labeled with  mark.
- To enjoy Dolby Digital, play back a software encoded with Dolby Digital and labeled with  mark.
- To enjoy DTS Digital Surround, play back a software encoded with DTS Digital Surround and labeled with  mark.

2. Press SURROUND ON/OFF to activate an appropriate Surround mode — PRO LOGIC, DOLBY DIGITAL or DTS SURROUND.



When "PRO LOGIC" is selected, the PRO LOGIC indicator lights up on the display.

- Each time you press the button, the Surround mode turns on and off alternately.

3. Press SOUND.

The 10 keys are activated for sound adjustments.

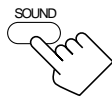

4. Press TEST to check the speaker output balance.

"TEST TONE L" starts flashing on the display, and a test tone comes out of the speakers in the following order:

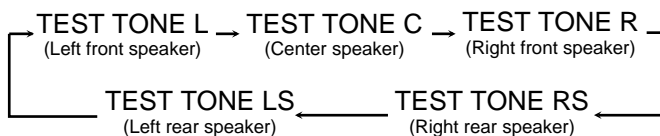
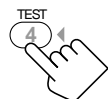

Notes:

- You can adjust the speaker output levels without outputting the test tone.
- No test tone comes out of the center speaker when "CENTER SPK" is set to "NO" (see page 14).
- No test tone comes out of the rear speakers when "REAR SPK" is set to "NO" (see page 14).

5. Adjust the speaker output levels.

- To adjust the center speaker level, press CENTER +/- (from +10 dB to -10 dB).
- To adjust the left rear speaker level, press REAR•L +/- (from +10 dB to -10 dB).
- To adjust the right rear speaker level, press REAR•R +/- (from +10 dB to -10 dB).

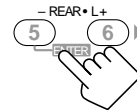
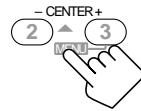

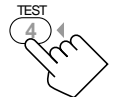

6. Press TEST again to stop the test tone.



On the front panel:

You can also use the buttons on the front panel to adjust the Surround modes. However, no test tone is available when using the buttons on the front panel. So, make adjustments while listening to the sound of the source played back.

1. Select and play a sound source.

- To enjoy Dolby Pro Logic, play back a software encoded with Dolby Surround and labeled with  mark.
- To enjoy Dolby Digital, play back a software encoded with Dolby Digital and labeled with  mark.
- To enjoy DTS Digital Surround, play back a software encoded with DTS Digital Surround and labeled with  mark.

2. Press SURROUND ON/OFF to activate an appropriate Surround mode — PRO LOGIC, DOLBY DIGITAL or DTS SURROUND.

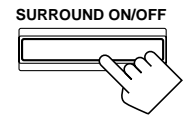

When "PRO LOGIC" is selected, the PRO LOGIC indicator lights up on the display.

- Each time you press the button, the Surround mode turns on and off alternately.

3. Adjust the speaker output levels.

- 1) Press ADJUST repeatedly until one of the following indications appears on the display.

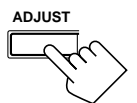

"CENTER LEVEL":

To adjust the center speaker level.

"REAR L LEVEL":

To adjust the left rear speaker level.

"REAR R LEVEL":

To adjust the right rear speaker level.

- 2) Press CONTROL UP ▲/DOWN ▼ to adjust the selected speaker output level (from +10 dB to -10 dB).

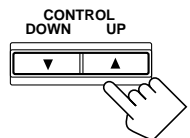

- 3) Repeat 1) and 2) to adjust the other speaker output levels.

JVC Theater Surround adjustments

Before you start, remember...

- Make sure that you have set the speaker information correctly (see page 14).
- There is a time limit in doing the following steps. If the setting is canceled before you finish, start from step 2 again.
- You cannot adjust the rear speaker output levels when you have set "REAR SPK" to "NO." See page 14.
- You cannot adjust the center speaker output level when you have set "CENTER SPK" to "NO." See page 14.

From the remote control:

1. Press DSP MODE repeatedly until "THEATER" appears on the display.

The PRO LOGIC and DSP indicators also light up on the display.



2. Press SOUND.

The 10 keys are activated for sound adjustments.

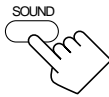

3. Press TEST to check the speaker output balance.

"TEST TONE L" starts flashing on the display, and a test tone comes out of the speakers in the following order:

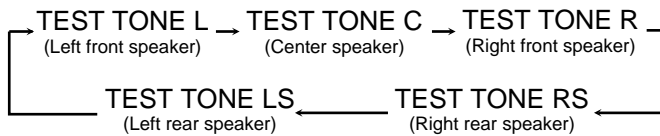

Notes:

- You can adjust the speaker output levels without outputting the test tone.
- No test tone comes out of the center speaker when "CENTER SPK" is set to "NO" (see page 14).
- No test tone comes out of the rear speakers when "REAR SPK" is set to "NO" (see page 14).

4. Adjust the speaker output levels.

- To adjust the center speaker level, press CENTER +/- (from +10 dB to -10 dB).
- To adjust the left rear speaker level, press REAR•L +/- (from +10 dB to -10 dB).
- To adjust the right rear speaker level, press REAR•R +/- (from +10 dB to -10 dB).

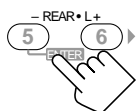
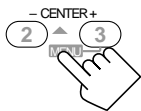

5. Press TEST again to stop the test tone.

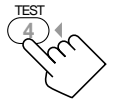

6. Press EFFECT to select an effect level you want.

- Each time you press the button, the effect level changes as follows:

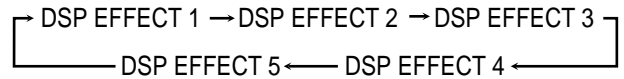
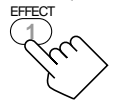

As the number increases, JVC Theater Surround becomes stronger (normally set it to "DSP EFFECT 3").

On the front panel:

You can also use the buttons on the front panel to adjust the Surround modes. However, no test tone is available when using the buttons on the front panel. So, make adjustments while listening to the sound of the source played back.

1. Press DSP MODE repeatedly until "THEATER" appears on the display.

The PRO LOGIC and DSP indicators also light up on the display.

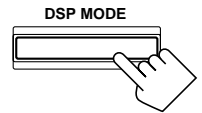

2. Adjust the speaker output levels.

- 1) Press ADJUST repeatedly until one of the following indications appears on the display.

"CENTER LEVEL":

To adjust the center speaker level.

"REAR L LEVEL":

To adjust the left rear speaker level.

"REAR R LEVEL":

To adjust the right rear speaker level.

- 2) Press CONTROL UP ▲/DOWN ▼ to adjust the selected speaker output level (from +10 dB to -10 dB).

- 3) Repeat 1) and 2) to adjust the other speaker output levels.

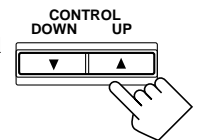
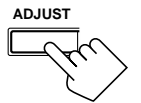

3. Adjust the effect level.

- 1) Press ADJUST repeatedly until "DSP EFFECT" appears on the display.

The display changes to show the current setting.

- 2) Press CONTROL UP ▲/DOWN ▼ to select the effect level.

- Each time you press the button, the effect level changes as follows:

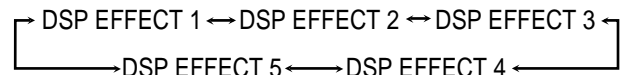
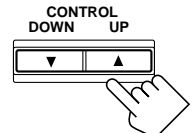
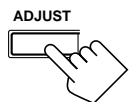

As the number increases, JVC Theater Surround becomes stronger (normally set it to "DSP EFFECT 3").

Adjusting the DAP Modes

Once you have adjusted the DAP modes, the adjustment is memorized for each DAP mode.

Before you start, remember...

- Make sure that you have set the speaker information correctly (see page 14).
- There is a time limit in doing the following steps. If the setting is canceled before you finish, start from step 1 again.
- You cannot adjust the rear speaker output level when you have set "REAR SPK" to "NO." See page 14.

On the front panel:

1. Press **DSP MODE** repeatedly until the DAP mode — **LIVE CLUB, DANCE CLUB, HALL, or PAVILION** — appears on the display.

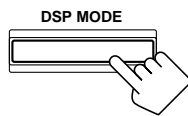

The DSP indicator also lights up on the display.

2. Adjust the rear speaker output levels.

- 1) Press **ADJUST** repeatedly until one of the following indications appears on the display.

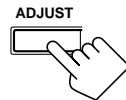

"REAR L LEVEL":

To adjust the left rear speaker level.

"REAR R LEVEL":

To adjust the right rear speaker level.

- 2) Press **CONTROL UP ▲/DOWN ▼** to adjust the selected speaker output level (from +10 dB to -10 dB).

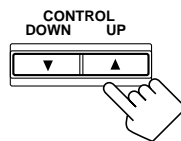

- 3) Repeat 1) and 2) to adjust the other speaker output level.

3. Adjust the effect level.

- 1) Press **ADJUST** repeatedly until "DSP EFFECT" appears on the display.

The display changes to show the current setting.

- 2) Press **CONTROL UP ▲/DOWN ▼** to select the effect level.

- Each time you press the button, the effect level changes as follows:

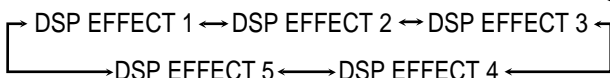
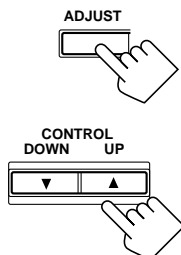

As the number increases, the selected DAP mode becomes stronger (normally set it to "DSP EFFECT 3").

From the remote control:

1. Press **DSP MODE** repeatedly until the DAP mode — **LIVE CLUB, DANCE CLUB, HALL, or PAVILION** — appears on the display.



The DSP indicator also lights up on the display.

2. Press **SOUND**.

The 10 keys are activated for sound adjustments.

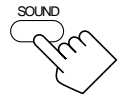

3. Adjust the rear speaker output levels.

- To adjust the left rear speaker level, press REAR•L +/- (from +10 dB to -10 dB).
- To adjust the right rear speaker level, press REAR•R +/- (from +10 dB to -10 dB).

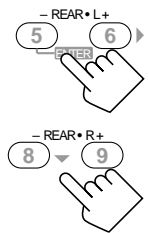

4. Press **EFFECT** to select an effect level you want.

- Each time you press the button, the effect level changes as follows:

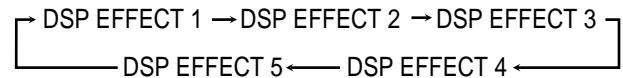
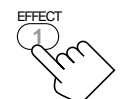

As the number increases, the selected DAP mode becomes stronger (normally set it to "DSP EFFECT 3").

Activating the DSP Modes

You can use only one DSP mode at a time. When a DSP mode is activated, another DSP mode is canceled if in use.

For Dolby Pro Logic, Dolby Digital, and DTS Digital Surround

1. Press SURROUND ON/OFF.

- Each time you press the button, the Dolby/DTS Surround turns on and off alternately.

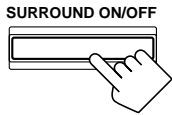



On the front panel

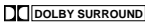

On the remote control

2. Select and play a sound source.

- To enjoy Dolby Pro Logic, play back a software encoded with Dolby Surround and labeled with  mark.
- To enjoy Dolby Digital, play back a software encoded with Dolby Digital and labeled with  mark.
- To enjoy DTS Digital Surround, play back a software encoded with DTS Digital Surround and labeled with  mark.

To cancel the Dolby/DTS Surround mode

Press SURROUND ON/OFF again. (“SURROUND OFF” appears on the display.)

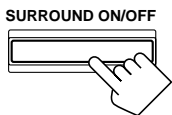

On the front panel



On the remote control

For the other DSP modes

1. Press DSP MODE repeatedly until the mode you want appears on the display.

- Each time you press the button, the DSP modes change. (See page 25 for more details.)

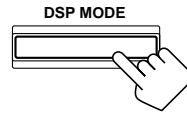

On the front panel

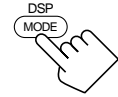

On the remote control

2. Select and play a sound source.

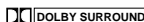
- To enjoy JVC Theater Surround, play back a software encoded with Dolby Surround and labeled with  mark.

To cancel the DSP mode

Press DSP MODE repeatedly until “DSP OFF” appears on the display.

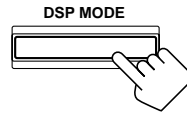

On the front panel



On the remote control

Using the DVD MULTI Playback Mode

This receiver provides the DVD MULTI playback mode for reproducing the analog discrete output mode of the DVD player. Before playing back a DVD, refer also to the manual supplied with the DVD player.

Activating the DVD MULTI Playback Mode

You can adjust the DVD MULTI playback mode while playing back a DVD using the analog discrete output mode on the DVD player. Once you have made adjustments, the receiver memorizes the adjustments until you change them. You also need to set the DVD player to the analog discrete output mode.

Before you start, remember...

- There is a time limit in doing the following steps. If the setting is canceled before you finish, start from step 1 again.

On the front panel:

1. Press DVD MULTI so that “DVD MULTI” appears on the display.



Note:

When you select “DVD MULTI” as the source to play, the DSP mode is canceled, and the SURROUND ON/OFF and DSP MODE buttons do not work.

2. Select the analog discrete output mode on the DVD player, and start playing a DVD.

- Refer to the manual supplied with the DVD player.

If you need to make any adjustment, go to the following steps.

3. Adjust the speaker output levels.

- 1) Press ADJUST repeatedly until one of the following indications appears on the display.

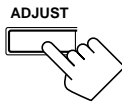

“CENTER LEVEL”:

To adjust the center speaker level.

“REAR L LEVEL”:

To adjust the left rear speaker level.

“REAR R LEVEL”:

To adjust the right rear speaker level.

- 2) Press CONTROL UP ▲/DOWN ▼ to adjust the selected speaker output level (from +10 dB to -10 dB).

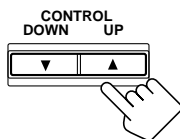

- 3) Repeat 1) and 2) to adjust the other speaker output levels.

From the remote control:

1. Press DVD MULTI so that “DVD MULTI” appears on the display.



Note:

When you select “DVD MULTI” as the source to play, the DSP mode is canceled, and the SURROUND ON/OFF and DSP MODE buttons do not work.

2. Select the analog discrete output mode on the DVD player, and start playing a DVD.

- Refer to the manual supplied with the DVD player.

If you need to make any adjustment, go to the following steps.

3. Press SOUND.

The 10 keys are activated for adjusting the sound.

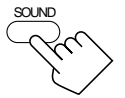

4. Adjust the speaker output levels.

- To adjust the center speaker level, press CENTER +/- (from +10 dB to -10 dB).
- To adjust the left rear speaker level, press REAR•L +/- (from +10 dB to -10 dB).
- To adjust the right rear speaker level, press REAR•R +/- (from +10 dB to -10 dB).

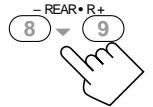
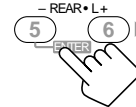
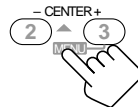

COMPU LINK Remote Control System

The COMPU LINK remote control system allows you to operate JVC audio components through the remote sensor on the receiver.

To use this remote control system, you need to connect JVC audio components through the COMPU LINK (SYNCHRO) jacks (see below) in addition to the connections using cables with RCA pin plugs (see pages 5 and 6).

- Make sure that the AC power cords of these components are unplugged before connection. Plug the AC power cords only after all connections are complete.

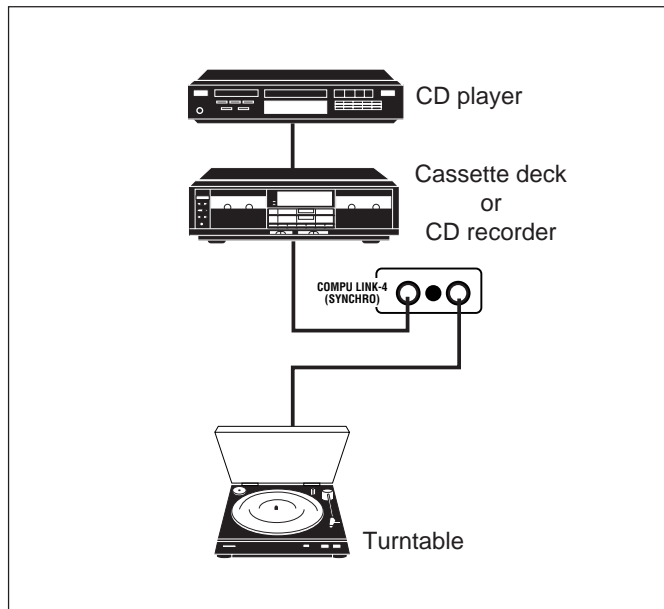

Notes:

- There are four versions of COMPU LINK remote control system. This receiver is equipped with the fourth version — COMPU LINK-4. This version is added systematic operations with the CD recorder to the previous version — COMPU LINK-3.
- If your audio component has two COMPU LINK jacks, you can use either one. If it has only one COMPU LINK jack, connect it so that it is the last item in the series of components. (For example, the turntable or CD player in the diagram above.)
- To operate the cassette deck or CD recorder using the COMPU LINK remote control system, set the source name correctly. (See page 13.)
- Refer also to the manuals supplied with your audio components.

This remote control system allows you to use four functions listed below.

Remote Control through the Remote Sensor on the Receiver

You can control the connected audio components through the remote sensor on the receiver using this remote control. Aim the remote control directly at the remote sensor on the receiver. For details, see pages 32 and 33.

Automatic Source Selection

When you press the play (▶) button on a connected component or on its own remote control, the receiver automatically turns on and changes the source to the component. On the other hand, if you select a new source on the receiver or on the remote control, the selected component begins playing immediately.

In both cases, the previously selected source continues playing without sound for a few seconds.

Automatic Power On/Off (Standby): only possible with the COMPU LINK-3 and COMPU LINK-4 connection

The connected components turn on and off (standby) along with the receiver.

When you turn on the receiver, one of the connected component will turn on automatically, depending on which component has been previously selected.

When you turn off the receiver, the connected components will turn off (standby).

Synchronized Recording

Synchronized recording means the cassette deck starts recording as soon as a CD or a record begins playing.

To use synchronized recording, follow these steps:

1. Put a tape in the cassette deck, and a disc in the CD player (or a record on the turntable).

2. Press the record (●) button and the pause (II) button on the cassette deck at the same time.

This puts the cassette deck into recording pause.

If you do not press the record (●) button and pause (II) button at the same time, the synchronized recording feature will not operate.

3. Press the play (▶) button on the CD player or on the turntable.

The source changes on the receiver, and as soon as play starts, the cassette deck starts recording. When the play ends, the cassette deck enters recording pause, and stops about 4 seconds later.

Notes:

- During synchronized recording, the selected source cannot be changed.
- If the power of any component is shut off during synchronized recording, the COMPU LINK remote control system may not operate properly. In this case, you must start again from the beginning.

Operating JVC's Audio/Video Components

You can operate JVC's audio and video components with this receiver's remote control, since control signals for JVC components are preset in the remote control.

Operating Audio Components

IMPORTANT:

To operate JVC's audio components using this remote control:

- You need to connect JVC audio components through the COMPU LINK (SYNCHRO) jacks (see page 31) in addition to the connections using cables with RCA pin plugs (see pages 5 and 6).
- Aim the remote control directly at the remote sensor on the receiver.
- If you use the buttons on the front panel, the remote control will not operate that source. To operate a source with the remote control, the source must be selected using source selecting buttons on the remote control.
- To operate the cassette deck or CD recorder using the COMPU LINK remote control system, set the source name correctly. (See page 13.)
- Refer also to the manuals supplied with your components.

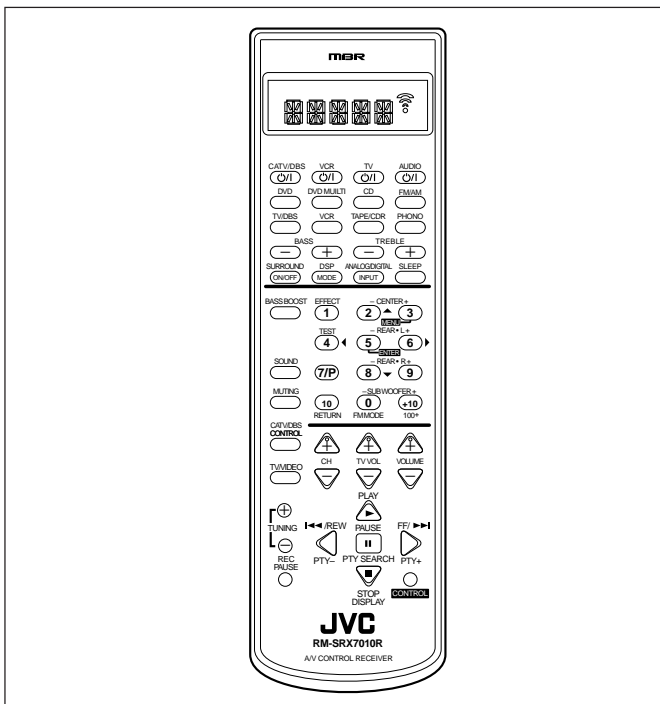

* When you press one of the following buttons, the remote control operation mode appears on the display window for about 10 seconds.

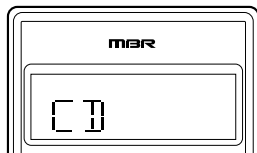

Ex.: When you press CD button

Buttons on the Remote Control	Remote Control Operation Mode
FM/AM	TUNER
CD	CD
PHONO	PHONO
TAPE/CDR	TAPE
DVD	DVD
DVD MULTI	DVD
TV/DBS	TV
VCR	VCR
CATV/DBS CONTROL	DBS
CONTROL	Current setting or VCR or TAPE or CDDSC
SOUND	SOUND

Tuner

You can always perform the following operations:

FM/AM: Alternates between FM and AM (MW/LW).

After pressing FM/AM, you can perform the following operations:

1 – 10, +10: Selects a preset channel number directly.
 For channel number 5, press 5.
 For channel number 15, press +10, then 5.
 For channel number 20, press +10, then 10.

TUNING +/-: Tunes into stations.

FM MODE: Changes the FM reception mode.

PTY SEARCH: Searches for a program by PTY codes.

PTY +/-: Selects the PTY codes.

DISPLAY: Shows the RDS signals.

Sound control section (Amplifier)

You can always perform the following operations:

SURROUND ON/OFF: Turns on or off the Surround modes – Dolby Pro Logic, Dolby Digital, and DTS Digital Surround.

DSP MODE: Selects the DSP modes.

After pressing SOUND, you can perform the following operations:

SUBWOOFER +/-: Adjusts the subwoofer output level.

CENTER +/-: Adjusts the center speaker output level.

REAR•L +/-: Adjusts the left rear speaker output level.

REAR•R +/-: Adjusts the right rear speaker output level.

EFFECT: Selects the effect level.

TEST: Turns on or off the test tone output.

Note:

After adjusting sounds, press the corresponding source selecting button to operate your target source by using the 10 keys; otherwise, the 10 keys cannot be used for operating your target source.

CD player

After pressing CD, you can perform the following operations on the CD player:

PLAY▶: Starts playing.

◀◀: Returns to the beginning of the current (or previous) track.

▶▶: Skips to the beginning of the next track.

STOP■: Stops playing.

PAUSE||: Pauses playing. To release it, press PLAY▶.

1 – 10, +10: Selects a track number directly.

For track number 5, press 5.

For track number 15, press +10, then 5.

For track number 20, press +10, then 10.

For track number 30, press +10, +10, then 10.

CD changer

After pressing CONTROL repeatedly until “CDDSC” appears on the display window, you can perform the following operations on the CD changer:

- PLAY▶: Starts playing.
- ◀◀: Returns to the beginning of the current (or previous) track.
- ▶▶: Skips to the beginning of the next track.
- STOP■: Stops playing.
- PAUSE▬: Pauses playing. To release it, press PLAY▶.
- 1 – 6, 7/P: Selects the number of a disc installed in a CD changer.

After pressing CD, you can perform the following operations on the CD changer:

- 1 – 10, +10: Selects a track number directly.
 - For track number 5, press 5.
 - For track number 15, press +10, then 5.
 - For track number 20, press +10, then 10.
 - For track number 30, press +10, +10, then 10.

EXAMPLE:

- Selecting disc number 4, track number 12, and starting playback.
 1. Press CONTROL repeatedly until “CDDSC” appears on the display window, then press 4.
 2. Press CD, then press +10, 2.

Turntable

After pressing PHONO, you can perform the following operations on a turntable:

- PLAY▶: Starts playing.
- STOP■: Stops operations.

Cassette deck

After pressing TAPE/CDR (or CONTROL repeatedly until “TAPE” appears on the display window), you can perform the following operations on a cassette deck:

- PLAY▶: Starts playing.
- REW: Fast winds the tape from right to left.
- FF: Fast winds the tape from left to right.
- STOP■: Stops operations.
- PAUSE▬: Pauses playing. To release it, press PLAY▶.
- REC PAUSE: Starts recording or enters recording pause.

CD recorder

After pressing TAPE/CDR (or CONTROL repeatedly until “TAPE” appears on the display window), you can perform the following operations on the CD recorder:

- PLAY▶: Starts playing.
- ◀◀: Returns to the beginning of the current (or previous) track.
- ▶▶: Skips to the beginning of the next track.
- STOP■: Stops playing.
- PAUSE▬: Pauses playing. To release it, press PLAY▶.
- REC PAUSE: Starts recording or enters recording pause.

Note:

You can use either TAPE/CDR button or CONTROL button to activate the buttons listed above. If you press TAPE/CDR, the playing source also changes. On the other hand, if you press CONTROL repeatedly to select “TAPE,” the playing source does not change.

Operating Video Components

IMPORTANT:

To operate JVC's video components using this remote control:

- Some JVC VCRs can accept two types of the control signals — remote code “A” and “B.” Before using this remote control, make sure that the remote control code of the VCR connected to the VCR jacks is set to code “A.”
- When using the remote control:
 - For the DVD player, TV, and VCR operations, aim the remote control directly at the remote sensor on each component, not on the receiver.

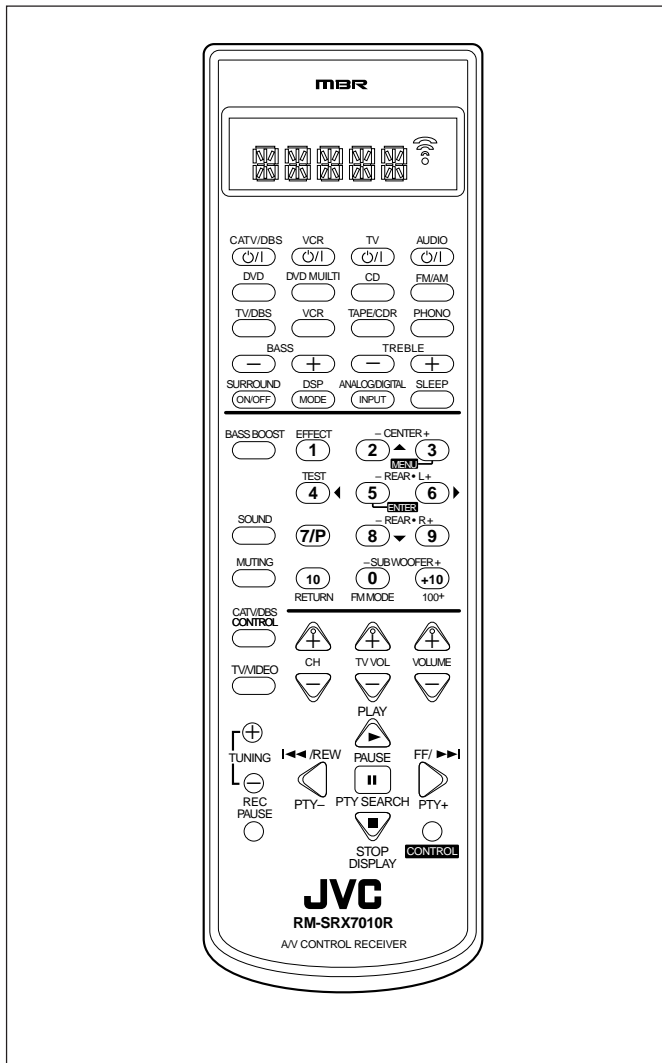

VCR

You can always perform the following operations:

VCR \odot/I : Turns on or off the VCR.

After pressing VCR (or CONTROL repeatedly until “VCR” appears on the display window), you can perform the following operations on the VCR:

- 1 – 9, 0: Selects the TV channels on VCR.
- PLAY \blacktriangleright : Starts playing.
- REW: Rewinds a tape.
- FF: Fast winds a tape.
- STOP \blacksquare : Stops operations.
- PAUSE II : Pauses playing. To release it, press PLAY \blacktriangleright .
- REC PAUSE: Starts recording or enters recording pause.
- CH +/-: Changes the TV channels on the VCR.

Note:

You can use either VCR button or CONTROL button to activate the buttons listed above. If you press VCR, the playing source also changes. On the other hand, if you press CONTROL repeatedly to select “VCR,” the playing source does not change.

DVD player

After pressing DVD or DVD MULTI, you can perform the following operations on a DVD player:

- PLAY \blacktriangleright : Starts playing.
- \lll : Returns to the beginning of the current (or previous) track.
- \ggg : Skips to the beginning of the next track.
- STOP \blacksquare : Stops playing.
- PAUSE II : Stops playing temporarily. To release it, press PLAY \blacktriangleright .

After pressing DVD or DVD MULTI, these buttons can be used for the DVD menu operations.

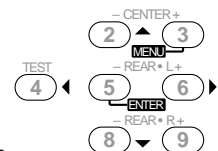

Note:

For detailed menu operations, refer to the instructions supplied with the discs or the DVD player.

TV

You can always perform the following operations:

- TV \odot/I : Turns on or off the TV.
- TV VOL +/-: Adjusts the volume.
- TV/VIDEO: Sets the input mode (either TV or VIDEO).

After pressing TV/DBS, you can perform the following operations on a TV:

- CH +/-: Changes the channels.
- 1 – 9, 0, 100+: Selects the channels.
- RETURN: Alternates between the previously selected channel and the current channel.

Operating Other Manufacturers' Video Equipment

This remote control supplied with the receiver can transmit control signals for other manufacturers' VCRs, TVs, CATV converters, DBS tuners, and DVD players. By changing the transmittable signals from preset ones to the other manufacturers', you can operate the other manufacturer's components using this remote control.

When operating the other manufacturers' components, refer also to the manuals supplied with them. To operate these components with the remote control, first you need to set the manufacturer's code each for VCR, TV, CATV converters, DBS tuner, and DVD player.

When replacing batteries of the remote control, set the manufacturers' codes again.

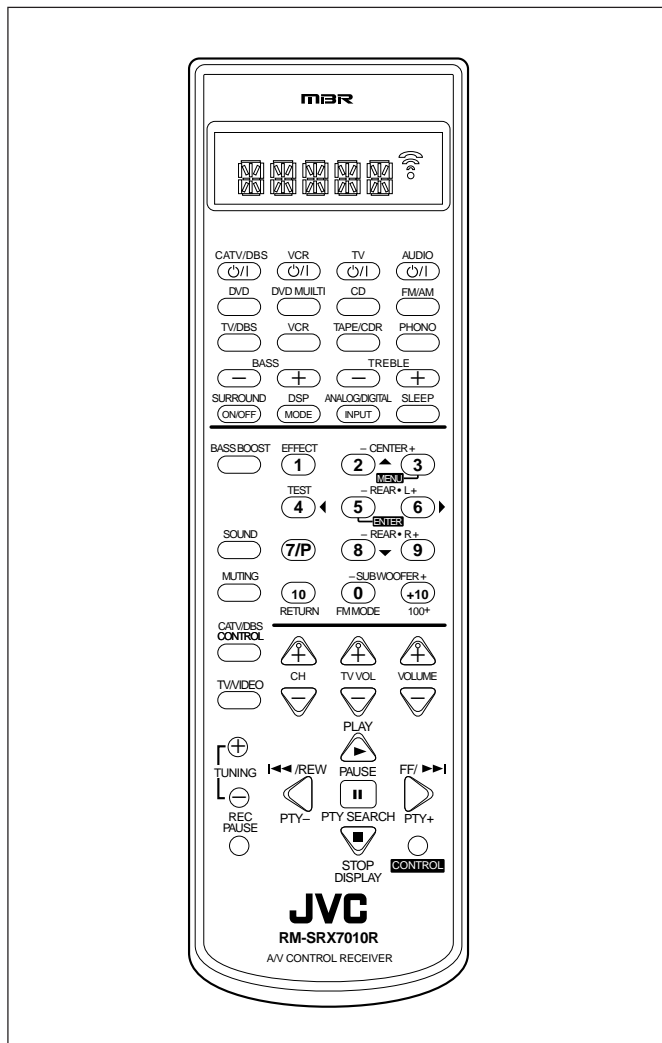

Manufacturers' codes are subject to change without notice. If they are changed, this remote control cannot operate the equipment.

To change the transmittable signals for operating another manufacturer's TV

1. Press and hold TV \odot /I.
2. Press TV/DBS.
3. Enter manufacturer's code using buttons 1-9, and 0.

See the list below to find the code.

4. Release TV \odot /I.

The following buttons can be used for operating the TV:

TV \odot /I: Turns on and off the TV.
 TV VOL +/-: Adjusts the volume.
 TV/VIDEO: Sets the input mode (either TV or VIDEO).

After pressing TV/DBS, you can perform the following operations on a TV:

CH +/-: Changes the channels.
 1 - 10, 0, 100+ (+10): Selects the channels.
 The 10 button will function as the ENTER button if your TV requires pressing ENTER after selecting a channel number.

Note:

Refer to the manual supplied with your TV.

5. Try to operate your TV by pressing TV \odot /I.

When your TV turns on or off, you have entered the correct code.

If there are more than one code listed for your brand of TV, try each one until the correct one is entered.

Manufacturer	Codes
JVC	00, 02, 13, 14, 47, 74
AKAI	01, 02
BLAUPUNKT	03, 04
FISHER	01, 05
GRUNDIG	03, 06, 07
HITACHI	08, 09, 10, 49
IRADDIO	02
ITT/NOKIA	11, 12
LOEWE	06, 15, 16
MAGNAVOX	08, 17, 49
METS	50, 51, 52, 53
MITSUBISHI	08, 18, 19, 20
MIVAR	21
NORDMENDE	22, 23
OKANO	15
PANASONIC	24, 25, 26, 27, 76
PHILIPS	15, 17, 28, 75
QUELLE	52, 53, 54, 55, 56, 57, 58, 59, 60, 61, 62, 63, 64, 65, 66, 67
RCA/PROSCAN	08, 24, 29, 30, 31, 48
SABA	32, 33, 68, 69, 70
SAMSUNG	06, 08, 16, 34, 35, 49
SANYO	01, 05
SCHNEIDER	02, 15, 36
SHARP	37, 38, 77
SONY	39
TELEFUNKEN	40, 41, 42, 69
THOMSON	71, 72
TOSHIBA	37, 43, 44
ZENITH	45, 46

To change the transmittable signals for operating a CATV converter or DBS tuner

1. Press and hold CATV/DBS $\odot/|$.
2. Press CATV/DBS CONTROL.
3. Enter manufacturer's code using buttons 1–9, and 0.
4. Release CATV/DBS $\odot/|$.

The following buttons can be used for operating the CATV converter or DBS tuner:

- CATV/DBS $\odot/|$: Turns on and off the CATV converter or DBS tuner.
- CH +/-: Changes the channels.
- 1 – 10, 0, 100+ (+10): Selects the channels. The 10 button will function as the ENTER button if your equipment requires pressing ENTER after selecting a channel number.

Note:

Refer to the manual supplied with your CATV converter or DBS tuner.

5. Try to operate your CATV converter or DBS tuner by pressing CATV/DBS $\odot/|$.

When your CATV converter or DBS tuner turns on or off, you have entered the correct code.

If there are more than one code listed for your brand of CATV converter or DBS tuner, try each one until the correct one is entered.

Note:

You cannot use both the CATV converter and DBS tuner at the same time.

For CATV converter

Manufacturer	Codes
GENERAL INSTRUMENT	06, 07, 08, 09, 10, 11, 12, 13, 14, 29
HAMLIN/REGAL	01, 02, 03, 04, 05
JERROLD	06, 07, 08, 09, 10, 11, 12, 13, 14
OAK	15, 16, 17
PANASONIC	18, 19, 20
PIONEER	21, 22
SCIENTIFIC ATLANTA	23, 24, 25
TOCOM	26
ZENITH	27, 28

Manufacturers' codes are subject to change without notice. If they are changed, this remote control cannot operate the equipment.

For DBS tuner

Manufacturer	Codes
JVC	56, 57, 67
AMSTRAD	43, 44, 45, 46, 47, 48, 49
BLAUPUNKT	30
ECHOSTAR	50, 51, 67
GOLDSTAR	31
GRUNDIG	32, 33
HIRSHMANN	48, 52, 53, 54, 55
INSTRUMENT	68
ITT/NOKIA	34
KATHREIN	52, 58, 59, 60, 61, 62, 63
NEC	35, 36
ORBITECH	48
PHILIPS	37, 38
RCA	65
SAMSUNG	39, 40
SCHWAIGER	61, 64
SIEMENS	41, 42
SONY	66
TECHNISAT	48

Manufacturers' codes are subject to change without notice. If they are changed, this remote control cannot operate the equipment.

To change the transmittable signals for operating another manufacturer's VCR

1. Press and hold VCR $\odot/|$.
2. Press VCR.
3. Enter manufacturer's code using buttons 1–9, and 0.

See the list to the right to find the code.

4. Release VCR $\odot/|$.

The following button can be used for operating the VCR:

VCR $\odot/|$: Turns on and off the VCR.

After pressing VCR, you can perform the following operations on the VCR:

CH +/-: Changes the TV channels on the VCR.
 1 – 10, 0, 100+ (+10): Selects the TV channels.
 The 10 button will function as the ENTER button if your VCR requires pressing ENTER after selecting a channel number.

PLAY▶: Starts playback.
 REW: Rewinds a video tape.
 FF: Fast winds a video tape.
 STOP■: Stops operation.
 PAUSE⏸: Pauses.
 REC PAUSE: Starts recording or enters recording pause.

Note:

Refer to the manual supplied with your VCR.

5. Try to operate your VCR by pressing VCR $\odot/|$.

When your VCR turns on or off, you have entered the correct code.

If there are more than one code listed for your brand of VCR, try each one until the correct one is entered.

Manufacturer	Codes
JVC	00, 26, 27, 28, 29, 58
AIWA	01, 02
BELL & HOWELL	03
BLAUPUNKT	04, 05
CGM	06, 07
EMERSON	08, 10, 11, 12, 64, 65
FISHER	03, 14, 15, 16, 17
FUNAI	01
GE	18, 19, 20
GOLDSTAR	07
GOODMANS	13, 21
GRUNDIG	06, 22
HITACHI	18, 23, 24, 25, 66
LOEWE	07, 21
MAGNAVOX	04, 19, 24
MITSUBISHI	30, 31, 32, 33, 34, 35
NEC	26, 27
NOKIA	03, 36
NORDMENDE	38
ORION	09
PANASONIC	19, 24, 39, 40
PHILIPS	04, 19, 21, 24, 41, 42
PHONOLA	21
RCA/PROSCAN	04, 18, 19, 23, 24, 43, 44, 45
SABA	38, 46
SAMSUNG	45, 47, 59, 61, 62, 63
SANYO	03, 48, 49
SHARP	37, 50
SIEMENS	03, 51
SONY	52, 53, 54
TELEFUNKEN	55, 60
TOSHIBA	43, 44
ZENITH	56, 57

Manufacturers' codes are subject to change without notice. If they are changed, this remote control cannot operate the equipment.

To change the transmittable signals for operating another manufacturer's DVD player

1. Press and hold AUDIO \odot /I.
2. Press DVD.
3. Enter manufacturer's code using buttons 1-9, and 0.

See the list to the right to find the code.

4. Release AUDIO \odot /I.

After pressing DVD or DVD MULTI, you can perform the following operations on a DVD player:

- PLAY▶: Starts playing.
- ◀◀: Returns to the beginning of the current (or previous) tracks.
- ▶▶: Skips to the beginning of the next track.
- STOP■: Stops playing.
- PAUSE⏸: Stops playing temporarily. To release it, press PLAY▶.

Manufacturer	Codes
JVC	00, 02
DENON	01
PANASONIC	03
PHILIPS	13
PIONEER	04, 05, 06
RCA	07
SAMSUNG	08
SONY	09
TOSHIBA	10
YAMAHA	11, 12

Manufacturers' codes are subject to change without notice. If they are changed, this remote control cannot operate the equipment.

After pressing DVD or DVD MULTI, these buttons can be used for the DVD menu operations.

Note:
For detailed menu operations, refer to the instructions supplied with the discs or the DVD player.

Note:
Refer to the manual supplied with your DVD player.

5. Try to operate your DVD player by pressing one of the above buttons.

- DO NOT forget to turn on the DVD player before pressing one of the above buttons.

If there are more than one code listed for your brand of DVD player, try each one until the correct one is entered.

Troubleshooting

Use this chart to help you solve daily operational problems. If there is any problem you cannot solve, contact your JVC service center.

PROBLEM	POSSIBLE CAUSE	SOLUTION
The display does not light up.	The power cord is not plugged in.	Plug the power cord into an AC outlet.
No sound from speakers.	Speaker signal cables are not connected.	Check speaker wiring and reconnect if necessary.
	The SPEAKERS ON/OFF 1 and 2 buttons are not set correctly.	Press SPEAKERS ON/OFF 1 and 2 correctly.
	An incorrect source is selected.	Select the correct source.
	Muting is activated.	Press MUTING to cancel the mute.
	An incorrect input mode (analog or digital) is selected.	Select the correct input mode (analog or digital).
Sound from one speaker only.	Connections are incorrect.	Check connections. For analog connections, see page 5. For digital connections, see page 8.
	Speaker signal cables are not connected properly.	Check speaker wiring and reconnect if necessary.
Continuous hiss or buzzing during FM reception.	The balance is set to one extreme.	Adjust the balance properly (see page 13).
	Incoming signal is too weak.	Connect an outdoor FM antenna or contact your dealer.
	The station is too far away.	Select a new station.
Occasional cracking noise during FM reception.	An incorrect antenna is used.	Check with your dealer to be sure you have the correct antenna.
	Antennas are not connected properly.	Check connections.
Howling during record playing.	Ignition noise from automobiles.	Move the antenna farther from automobile traffic.
Noise is heard.	Your turntable is too close to speakers.	Move speakers away from the turntable.
"OVERLOAD" starts flashing on the display.	An earth (⏏) cable is not connected to the AM (⏏) terminal on the rear panel.	Connect the cable to the AM (⏏) terminal on the rear panel.
	Speakers are overloaded because of high volume.	1. Press STANDBY/ON (⏏) on the front panel to turn off the receiver. 2. Stop the playback source. 3. Turn on the receiver again, and adjust the volume.
"DSP MICON NG" starts flashing on the display.	Speakers are overloaded because of short circuit of speaker terminals.	Press STANDBY/ON (⏏) on the front panel, then check the speaker wiring. If "OVERLOAD" does not disappear, unplug the AC power cord, then plug it back again. If speaker wiring is not short-circuited, contact your dealer.
	The built-in microcomputer is not functioning correctly.	Press STANDBY/ON (⏏) on the front panel to turn off the receiver. After unplugging the power cord, consult your dealer.
The STANDBY lamp lights up after turning on the power, but soon the receiver turns off (into standby mode).	The receiver is overloaded because of a high voltage.	Press STANDBY/ON (⏏) on the front panel to turn off the receiver. After unplugging the power cord, consult your dealer.
Remote control does not work.	There is an obstruction in front of the remote sensor on the receiver.	Remove the obstruction.
	Batteries are weak.	Replace batteries.
Remote control does not operate intendedly.	An incorrect remote control operation mode is selected.	Select the correct remote control operation mode. (See page 32).

Note:

When you use the digital coaxial connection, the sounds may be intermitted by the outside noise such as a lightning discharge but they will restore automatically. This is not a malfunction.

Specifications

Amplifier

Output Power

At Stereo operation:

Front channels: 100 W per channel, min. RMS, both channels driven into 8 Ω at 1 kHz with no more than 0.9% total harmonic distortion. (IEC268-3/DIN)

At Surround operation:

Front channels: 100 W per channel, min. RMS, driven into 8 Ω at 1 kHz with no more than 0.8% total harmonic distortion.

Center channel: 100 W, min. RMS, driven into 8 Ω at 1 kHz, with no more than 0.8% total harmonic distortion.

Rear channels: 100 W per channel, min. RMS, driven into 8 Ω at 1 kHz, with no more than 0.8% total harmonic distortion.

Audio

Audio Input Sensitivity/Impedance (1 kHz):

PHONO (MM): 2.7 mV/47 k Ω
CD, TAPE/CDR, TV SOUND/DBS, VCR, DVD:
220 mV/47 k Ω

Audio Input (DIGITAL IN)* :

Coaxial: DIGITAL 1 (DVD): 0.5 V(p-p)/75 Ω
Optical: DIGITAL 2 (CD), DIGITAL 3 (TV), DIGITAL 4 (CDR):
-21 dBm to -15 dBm (660 nm \pm 30 nm)
*Corresponding to Linear PCM, Dolby Digital, and DTS Digital Surround (with sampling frequency — 32 kHz, 44.1 kHz, 48 kHz).

Audio Output Level:

TAPE/CDR, VCR: 220 mV

Digital output:

Optical: DIGITAL OUTPUT
Signal wave length: 660 nm
Output level: -21 dBm to -15 dBm

Signal-to-Noise Ratio ('66 IHF/DIN):

PHONO (MM): 70 dB/66 dB (at REC OUT)
CD, TAPE/CDR, TV SOUND/DBS, VCR, DVD:
87 dB/67 dB

Frequency Response (8 Ω):

PHONO: 20 Hz to 20 kHz (\pm 1 dB)
CD, TAPE/CDR, TV SOUND/DBS, VCR, DVD:
20 Hz to 20 kHz (\pm 1 dB)

RIAA Phono Equalization: \pm 10 dB (20 Hz to 20 kHz)

Bass boost: +3 dB \pm 1.0 dB at 100 Hz

Tone Control:

Bass (100 Hz): \pm 10 dB
Treble (10 kHz): \pm 10 dB

Video

Video Input Sensitivity/Impedance:

Composite video: DBS, VCR, DVD: 1 V(p-p)/75 Ω
S-video: DBS, VCR, DVD: (Y: luminance): 1 V(p-p)/75 Ω
(C: chrominance, burst): 0.286 V(p-p)/75 Ω

Video Output Level:

Composite video: VCR, MONITOR OUT:
1 V(p-p)/75 Ω
S-video: VCR, MONITOR OUT:
(Y: luminance): 1 V(p-p)/75 Ω
(C: chrominance, burst): 0.286 V(p-p)/75 Ω

Synchronization: Negative

Signal-to-Noise Ratio: 45 dB

FM tuner (IHF)

Tuning Range: 87.50 MHz to 108.00 MHz

Usable Sensitivity: Monaural: 17.0 dBf (1.95 μ V/75 Ω)

50 dB Quieting Sensitivity:

Monaural: 21.3 dBf (3.2 μ V/75 Ω)
Stereo: 41.3 dBf (31.5 μ V/75 Ω)

Signal-to-Noise Ratio (IHF-A weighted):

Monaural: 78 dB at 85 dBf
Stereo: 73 dB at 85 dBf

Total Harmonic Distortion:

Monaural: 0.4% at 1 kHz
Stereo: 0.6% at 1 kHz

Stereo Separation at REC OUT: 35 dB at 1 kHz

Alternate Channel Selectivity: 60 dB: (\pm 400 kHz)

Frequency Response: 30 Hz to 15 kHz: (+0.5 dB, -3 dB)

AM (MW/LW) tuner

Tuning Range: MW: 522 kHz to 1 629 kHz
LW: 144 kHz to 288 kHz

Usable Sensitivity: Loop antenna: 400 μ V/m (MW)

Signal-to-Noise Ratio: 50 dB (100 mV/m)

General

Power Requirements: AC 230V \sim , 50 Hz

Power Consumption: 200 W (at operation)
2 W (in standby mode)

Dimensions (W x H x D): 435 mm x 146.5 mm x 425.5 mm
(17 ³/₁₆ in. x 5 ¹³/₁₆ in. x 16 ¹³/₁₆ in.)

Mass: 8.6 kg (19.0 lbs)

Designs & specifications are subject to change without notice.

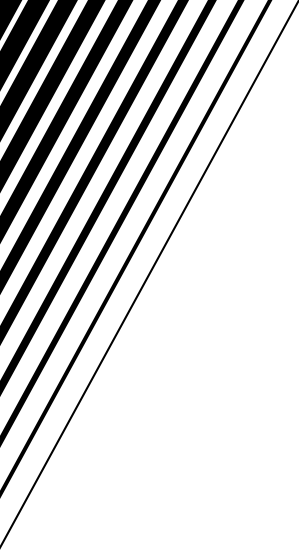

JVC
VICTOR COMPANY OF JAPAN, LIMITED